

3 - TeSys protection components: motor circuit-breakers

TeSys GV thermal-magnetic motor circuit-breakers

Selection guide page 3/2

- Presentation page 3/6
- Characteristics page 3/8
- References page 3/46
- Dimensions, mounting page 3/66
- Schemes page 3/76

TeSys GV magnetic motor circuit-breakers

Selection guide page 3/4

- Characteristics page 3/14
- References page 3/52
- Dimensions, mounting page 3/78
- Schemes page 3/83

TeSys GB2 thermal-magnetic circuit breakers for the protection of control circuits, solenoid valves and transformers

Selection guide page 3/84

- Presentation page 3/86
- Characteristics page 3/87
- References page 3/90
- Dimensions page 3/91
- Schemes page 3/91



Applications

Protection of motors against short-circuits and overloads



3

Tripping threshold on short-circuit

13 In

Standard motor power ratings in AC-3, 415 V

Up to 15 kW

Up to 30 kW

37 kW

Operational current at 415 V

0.1...32 A

9...65 A

56...80 A

Breaking capacity at 415 V (Icu) to IEC 60947-2

10...100 kA

35...100 kA

50...100 kA

15 kA

Door interlock mechanism

Without

With

With

Without

Circuit-breaker type

GV2 ME

GV2 P

GV3 P

GV3 ME80

Pages

3/46 and 3/47

3/48

3/48

3/48

Protection of motors with high current peak on starting



3

7.5...110 kW

12...220 A

35 and 36 kA

With

GV7 RE

3/49

70 kA

GV7 RS

20 In

Up to 11 kW

0.25...23 A

15...100 kA

With

GV2 RT

3/50 and 3/51

Applications

Protection of motors

Magnetic circuit-breakers provide short-circuit protection. They must be combined with thermal overload relays to provide motor overload protection.



3

Tripping threshold on short-circuit

13 I_n

Standard motor power ratings in AC-3, 415 V

Up to 15 kW

Operational current at 415 V

0.4...32 A

Breaking capacity at 415 V (I_{cu}) to IEC 60947-2

10...100 kA

35...100 kA

Door interlock mechanism

With

Circuit-breaker type

GV2 LE

GV2 L

Pages

3/52

3/53



		6...14 In	8...13 In	6.3...12.5 In
Up to 30 kW	37 kW	0.37...250 kW		
25...65 A	80 A	1.5...500 A		
50...100 kA	35 kA	25.7 and 150 kA	35.7...150 kA	45.7...150 kA
With	With	With		
GV3 L	GK3 EF80	NS 80	NS 100 to NS 250	NS 400 and NS 630
3/53	3/53	Please consult the Schneider Electric catalogue - Low Voltage Distribution		

TeSys protection components

Thermal-magnetic motor circuit-breakers GV2, GV3 and GV7

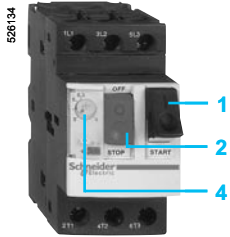

526134
GV2 ME
with screw clamp
terminals

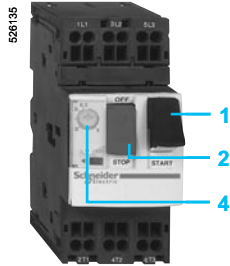

526135
GV2 ME
with spring terminals
connections

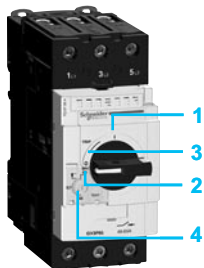

526148
GV3 P

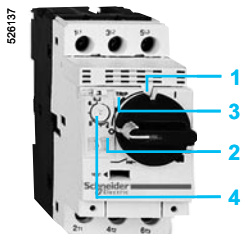

526137
GV2 P

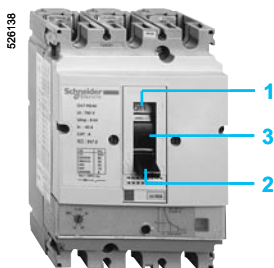

526138
GV7 R

Presentation

GV2 ME, GV2 P, GV3 ME, GV3 P and GV7 R motor circuit-breakers are 3-pole thermal-magnetic circuit-breakers **specifically designed for the control and protection of motors**, conforming to standards IEC 60947-2 and IEC 60947-4-1.

Connection

GV2

GV2 ME and GV2 P circuit-breakers are designed for connection by screw clamp terminals.

Circuit-breaker GV2 ME can be supplied with lugs or spring terminal connections. Spring terminal connections ensure secure, permanent and durable clamping that is resistant to harsh environments, vibration and impact and are even more effective when conductors without cable ends are used. Each connection can take two independent conductors.

GV3

GV3 circuit-breakers feature connection by BTR screws (hexagon socket head), tightened using a n° 4 Allen key.

This type of connection uses the **EverLink®** system with creep compensation (1) (Schneider Electric patent).

This technique makes it possible to achieve accurate and durable tightening torque, in order to avoid cable creep.

GV3 circuit-breakers are also available with connection by lugs. This type of connection meets the requirements of certain Asian markets and is suitable for applications subject to strong vibration, such as railway transport.

GV7

GV7 circuit-breakers: with connection by screw clamp terminals (for bars and lugs) and by clip-on connectors.

Operation

Control is manual and local when the motor circuit-breaker is used on its own. Control is automatic and remote when it is associated with a contactor.

GV2 ME and GV3 ME80

Pushbutton control.

Energisation is controlled manually by operating the Start button "I" **1**. De-energisation is controlled manually by operating the Stop button "O" **2**, or automatically by the thermal-magnetic protection elements or by a voltage trip attachment.

GV2 P, GV3 P and GV7 R

- Control by rotary knob: for GV2 P and GV3 P
- Control by rocker lever: for GV7 R.

Energisation is controlled manually by moving the knob or rocker lever to position "I" **1**. De-energisation is controlled manually by moving the knob or rocker lever to position "O" **2**. De-energisation due to a fault automatically places the knob or rocker lever in the "Trip" position **3**. Re-energisation is possible only after having returned the knob or rocker lever to position "O".

(1) Creep: normal crushing phenomenon of copper conductors, that is accentuated over time.

Presentation (continued)

Protection of motors and personnel

Motor protection is provided by the thermal-magnetic protection elements incorporated in the motor circuit-breaker.

The **magnetic** elements (short-circuit protection) have a non-adjustable tripping threshold, which is equal to 13 times the maximum setting current of the thermal trips.

The **thermal** elements (overload protection) include automatic compensation for ambient temperature variations.

The rated operational current of the motor is displayed by means of a graduated knob 4. Personnel protection is also provided. All live parts are protected against direct finger contact from the front panel.

The addition of an undervoltage trip allows the circuit-breaker to be de-energised in the event of an undervoltage condition. The user is therefore protected against sudden starting of the machine when normal voltage is restored, since the Start button "I" has to be pressed to restart the motor.

With the addition of a shunt trip, de-energisation of the unit can be remotely controlled.

The operators on both open-mounted and enclosed motor circuit-breakers can be locked in the Stop position "O" by up to 4 padlocks.

Because they are suitable for isolation, these circuit-breakers, in the open position, provide an adequate isolation distance and indicate the actual position of the moving contacts by the position of the operators.

Special features

These motor circuit-breakers are easily installed in any configuration thanks to their universal fixing arrangement: screw fixing or clip-on mounting on symmetrical, asymmetrical or combination rails.

3

Environment			GV2 ME	GV2 P	GV3 P	GV3 ME80	GV7 R	
Circuit-breaker type			GV2 ME	GV2 P	GV3 P	GV3 ME80	GV7 R	
Conforming to standards			IEC 60947-1, 60947-2, 60947-4-1, EN 60204, UL 508, CSA C 22.2 n° 14-05, NF C 63-650, 63-120, 79-130, VDE 0113, 0660		IEC/EN 60947-1, 60947-2, 60947-4-1, UL 508 type E, CSA C 22.2 n° 14-05 type E	IEC/EN, NF EN, BS EN, DIN EN 60947-2, 60947-4-1	IEC 60947-1, 60947-2, 60947-4-1, EN 60947-1, 60947-2, EN 60947-4-1, NF C 63-650, NF C 63-120, 79-130, VDE 0113, 0660	
Product certifications			UL, CSA, CCC, CEBC, GOST, TSE, BV, GL, LROS, DNV, PTB, EZU, SETI, RINA, ATEX	UL (1), CSA, PTB, EZU, GOST, TSE, DNV, LROS, GL, BV, RINA, CCC, ATEX	UL, CSA, CCC (pending), GOST, ATEX (pending)	UL, CSA, LROS	UL, DNV, CCC	
Protective treatment			"TH"		"TH"	"TC"	"TC"	
Degree of protection	Conforming to IEC 60529	Open mounted	IP 20		IP 20	IP 20	IP 405 with terminal shrouds	
		In enclosure	GV2 M●01: IP 41 GV2 M●02: IP 55	–	GV3 PC01 and GV3 PC02: IP 55	GV3 CE01: IP 55	–	
Shock resistance	Conforming to IEC 60068-2-27		30 gn -11 ms		On: 15 gn -11 ms Off: 30 gn -11 ms	22 gn - 20 ms	15 gn -11 ms	
Vibration resistance	Conforming to IEC 60068-2-6		5 gn (5...150 Hz)		4 gn (5...300 Hz)	2.5 gn (0...25 Hz)	2.5 gn (25 Hz)	
Ambient air temperature	Storage	°C	-40...+80	-40...+80	-40...+80	-40...+80	-55...+95	
	Operation	Open mounted	°C	-20...+60	-20...+60	-20...+60 (2)	-20...+60	-25...+70
		In enclosure	°C	-20...+40	-20...+40	-20...+40	-20...+40	–
Temperature compensation	Open mounted	°C	-20...+60	-20...+60	-20...+60	-20...+60	-25...+55 (3)	
	In enclosure	°C	-20...+40	-20...+40	-20...+40	-20...+40	–	
Flame resistance	Conforming to IEC 60695-2-1	°C	960		960	960	960	
Maximum operating altitude		m	2000		3000	3000	2000	
Suitable for isolation	Conforming to IEC 60947-1 § 7-1-6		Yes		Yes	–	Yes	
Resistance to mechanical impact		J	0.5	0.5	10	0.5	0.5	
			IK 04		IK 09 (in enclosure)	–	–	
Sensitivity to phase failure			Yes, conforming to IEC 60947-4-1 § 7-2-1-5-2					

Technical characteristics			GV2 ME	GV2 P	GV2 RT	GV3 P	GV3 ME80	GV7 R●20... R●100	GV7 R●150	GV7 R●220
Circuit-breaker type			GV2 ME	GV2 P	GV2 RT	GV3 P	GV3 ME80	GV7 R●20... R●100	GV7 R●150	GV7 R●220
Utilisation category	Conforming to IEC 60947-2		A			A	A	A		
	Conforming to IEC 60947-4-1		AC-3			AC-3	AC-3	AC-3		
Rated operational voltage (U_e)	Conforming to IEC 60947-2	V	690			690	690	690		
Rated insulation voltage (U_i)	Conforming to IEC 60947-2	V	690			690	690	750		
Rated voltage	Conforming to CSA C22-2 n° 14, UL 508	V	600			600	600 (B600)	600		
Rated operational frequency	Conforming to IEC 60947-4-1 UL, CSA	Hz	50/60			50/60	50/60	50/60		
Rated impulse withstand voltage (U_{imp})	Conforming to IEC 60947-2	kV	6			6	6	8		
Total power dissipated per pole		W	2.5			8	8	5	8.7	14.5
Mechanical durability (C.O.: Close, Open)		C.O.	100 000			50 000	30 000	50 000	40 000	20 000
Electrical durability for AC-3 duty	440 V In/2	C.O.	100 000			–	30 000	50 000	40 000	20 000
	440 V In	C.O.	–			50 000	–	30 000	20 000	10 000
Duty class (maximum operating rate)		C.O./h	25			25	25	25		
Maximum conventional rated thermal current (I_{th})	Conforming to IEC 60947-4-1	A	0.16... 32	0.16... 32	0.40... 23	13... 65	80	12... 100	150	220
Rated duty	Conforming to IEC 60947-4-1		Continuous duty							

(1) UL 508 type E for GV2 P●●H7

(2) Leave a space of 9 mm between 2 circuit-breakers: either an empty space, or side mounting add-on contact blocks. Side by side mounting is possible up to 40 °C.

(3) For operation up to 70 °C, please consult your Regional Sales Office.

Mounting characteristics

Operating position
Without derating, in relation to normal vertical mounting plane (1)

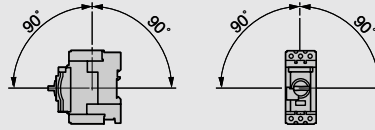

Connection characteristics

Connection to screw clamp terminals or spring terminals

Bare cables

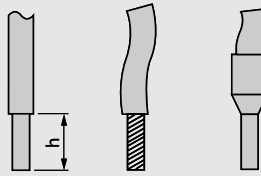

Circuit-breaker type			GV2 ME		GV2 P		GV3 P		GV3 ME80	
Connection to screw clamp terminals (2) (Max. number of conductors x c.s.a.)		mm ²	Min.	Max.	Min.	Max.	Min.	Max.	Min.	Max.
	Solid cable	mm ²	2 x 1	2 x 6	2 x 1	2 x 6	2 x 1	1 x 25 and 1 x 35	1 x 2.5	1 x 35
	Flexible cable without cable end	mm ²	2 x 1.5	2 x 6	2 x 1.5	2 x 6	2 x 1	1 x 25 and 1 x 35	1 x 2.5	2 x 16
	Flexible cable with cable end	mm ²	2 x 1	2 x 4	2 x 1	2 x 4	2 x 1	1 x 25 and 1 x 35	1 x 2.5	2 x 16
Tightening torque		N.m	1.7	1.7	1.7	1.7	5	5: 25 mm ² 8: 35 mm ²	5	5
Connection to spring terminals										
Number of conductors x c.s.a.										
	Solid cable	mm ²	2 x 1 (3)	2 x 6	–	–	–	–	–	–
	Flexible cable without cable end	mm ²	2 x 1.5 (3)	2 x 4	–	–	–	–	–	–

Connection by bars or lugs

Bars or lugs

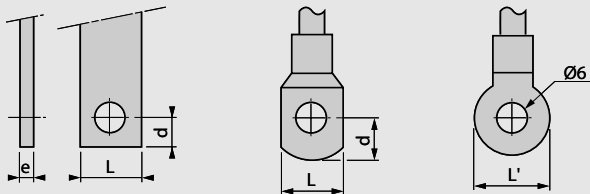

Circuit-breaker type			GV2 ME●●6	GV3 P●●6	GV7 R●20...R●100	GV7 R●150	GV7 R●220
Pitch	Without spreaders	mm	13.5	17.5	35	35	35
	With spreaders	mm	–	–	45	45	45
Bars or cables with lugs	e	mm	≤ 6	≤ 6	≤ 6	≤ 6	≤ 6
	L	mm	≤ 9.5	≤ 13.5	≤ 25	≤ 25	≤ 25
	L'	mm	≤ 9.5	≤ 16.5	–	–	–
	d	mm	≤ 10	≤ 10	≤ 10	≤ 10	≤ 10
Screws			M4	M6	M6	M8	M8
	Tightening torque	N.m	1.7	6	10	15	15
Bare cables (copper or aluminium) with connectors	Height (h)	mm	–	–	20	20	20
	C.s.a.	mm ²	–	–	1.5...95	1.5...95	1.5...185
	Tightening torque	N.m	–	–	15	15	15

(1) When mounting on a vertical rail, fit a stop to prevent any slippage.
 (2) For motor circuit-breakers **GV3 P**: BTR hexagon socket head screws, **EverLink®** system. Require use of an insulated Allen key, in compliance with local electrical wiring regulations.
 (3) For cross-sections 1 to 1.5 mm², the use of an **LA9 D99** cable end reducer is recommended.

TeSys protection components

Thermal-magnetic motor circuit-breakers

GV2 ME and GV2 P

3

Breaking capacity of GV2 ME and GV2 P																							
Circuit-breaker type			GV2 ME									GV2 P											
			01 to 06	07	08	10	14	16	20	21 & 22	32	01 to 06	07	08	10	14	16	20	21 & 22	32			
Rating			A	0.1 to 1.6	2.5	4	6.3	10	14	16	18	23 & 25	32	0.1 to 1.6	2.5	4	6.3	10	14	16	18	23 & 25	32
Breaking capacity conforming to IEC 60947-2	230/240 V	Icu	kA	*	*	*	*	*	*	*	*	50	50	*	*	*	*	*	*	*	*	*	*
		Ics % (1)		*	*	*	*	*	*	*	*	100	100	*	*	*	*	*	*	*	*	*	*
	400/415 V	Icu	kA	*	*	*	*	*	15	15	15	10	*	*	*	*	*	*	*	50	50	50	
		Ics % (1)		*	*	*	*	*	50	50	40	50	*	*	*	*	*	*	*	50	50	50	
	440 V	Icu	kA	*	*	*	50	15	8	8	6	6	*	*	*	*	*	*	50	20	20	20	
		Ics % (1)		*	*	*	100	100	50	50	50	50	*	*	*	*	*	*	75	75	75	75	
	500 V	Icu	kA	*	*	*	50	10	6	6	4	4	*	*	*	*	*	50	42	10	10	10	
		Ics % (1)		*	*	*	100	100	75	75	75	75	*	*	*	*	*	100	75	75	75	75	
	690 V	Icu	kA	*	3	3	3	3	3	3	3	3	*	8	8	6	6	6	4	4	4	4	
		Ics % (1)		*	75	75	75	75	75	75	75	75	*	100	100	100	100	100	100	100	100	100	
Associated fuses (if required) if Isc > breaking capacity Icu conforming to IEC 60947-2	230/240 V	aM	A	*	*	*	*	*	*	*	80	80	*	*	*	*	*	*	*	*	*	*	
		gG	A	*	*	*	*	*	*	*	100	100	*	*	*	*	*	*	*	*	*	*	
	400/415 V	aM	A	*	*	*	*	*	63	63	80	80	*	*	*	*	*	*	*	100	100	100	
		gG	A	*	*	*	*	*	80	80	100	100	*	*	*	*	*	*	*	125	125	125	
	440 V	aM	A	*	*	*	50	50	50	50	63	63	*	*	*	*	*	*	50	63	80	80	
		gG	A	*	*	*	63	63	63	63	80	80	*	*	*	*	*	*	63	80	100	100	
	500 V	aM	A	*	*	*	50	50	50	50	50	50	*	*	*	*	*	50	50	50	50	50	
		gG	A	*	*	*	63	63	63	63	63	63	*	*	*	*	*	63	63	63	63	63	
	690 V	aM	A	*	16	25	32	32	40	40	40	40	*	20	25	40	40	50	50	50	50	50	
		gG	A	*	20	32	40	40	50	50	50	50	*	25	32	50	50	63	63	63	63	63	

* > 100 kA.
(1) As % of Icu.

Breaking capacity of GV2 ME and GV2 P (used in association with current limiter GV1 L3)														
Circuit-breaker type				GV2 ME										
Rating				A	01 to 06 0.1 to 1.6	07 2.5	08 4	10 6.3	14 10	16 14	20 18	21 23	22 25	32 32
Breaking capacity conforming to IEC 60947-2	230/240 V	Icu	kA	*	*	*	*	*	*	*	*	*	*	*
		Ics % (1)		*	*	*	*	*	*	*	*	*	*	*
	400/415 V	Icu	kA	*	*	*	*	*	*	100	100	100	100	100
		Ics % (1)		*	*	*	*	*	*	50	50	40	40	40
	440 V	Icu	kA	*	*	*	*	*	*	50	20	20	20	20
		Ics % (1)		*	*	*	*	*	*	75	75	75	75	75
	500 V	Icu	kA	*	*	*	*	*	50	42	10	10	10	10
		Ics % (1)		*	*	*	*	*	100	100	75	75	75	75
Circuit-breaker type				GV2 P										
Rating				A	01 to 06 0.1 to 1.6	07 2.5	08 4	10 6.3	14 10	16 14	20 18	21 23	22 25	32 32
Breaking capacity conforming to IEC 60947-2	230/240 V	Icu	kA	*	*	*	*	*	*	*	*	*	*	*
		Ics % (1)		*	*	*	*	*	*	*	*	*	*	*
	400/415 V	Icu	kA	*	*	*	*	*	*	*	*	*	*	*
		Ics % (1)		*	*	*	*	*	*	*	*	*	*	*
	440 V	Icu	kA	*	*	*	*	*	*	100	100	100	100	100
		Ics % (1)		*	*	*	*	*	*	50	50	50	50	50
	500 V	Icu	kA	*	*	*	*	*	100	100	100	100	100	100
		Ics % (1)		*	*	*	*	*	50	50	50	50	50	50
	690 V (3)	Icu = Ics	kA	*	50	50	50	50	50	50	50	50	50	50
Circuit-breaker type				GV2 ME										
Rating				A	01 to 06 0.1 to 1.6	07 2.5	08 4	10 6.3	14 10	16 14	20 18	21 23	22 25	32 32
Cable protection against thermal stress in the event of short-circuit (PVC insulated copper cables)	Minimum c.s.a. protected at 40 °C at Isc max.	1 mm ²		•	•	•	•	≤ 10 kA	≤ 6 kA	(2)	(2)	(2)	(2)	(2)
		1.5 mm ²		•	•	•	•	≤ 20 kA	≤ 10 kA	(2)	(2)	(2)	(2)	(2)
		2.5 mm ²		•	•	•	•	•	•	•	•	•	•	(2)
		4...6 mm ²		•	•	•	•	•	•	•	•	•	•	•

★ > 100 kA
 ● Cable c.s.a. protected
 (1) As % of Icu
 (2) Cable c.s.a. not protected
 (3) With limiter LA9 LB920

3

Breaking capacity of GV3 P and GV3 ME80												
Motor circuit-breaker type			A	GV3 P						GV3 ME80		
				13	18	25	32	40	50		65	
Rating				13	18	25	32	40	50	65	80	
Breaking capacity conforming to IEC 60947-2	230/240 V	l _{cu}	kA	100	100	100	100	100	100	100	100	
		l _{cs} % (1)		100	100	100	100	100	100	100	100	
	400/415 V	l _{cu}	kA	100	100	100	100	50	50	50	15	
		l _{cs} % (1)		100	100	100	100	100	100	100	50	
	440 V	l _{cu}	kA	50	50	50	50	50	50	50	10	
		l _{cs} % (1)		100	100	100	100	100	100	100	60	
	500 V	l _{cu}	kA	12	12	12	12	12	12	12	4	
		l _{cs} % (1)		50	50	50	50	50	50	50	100	
	690 V	l _{cu}	kA	6	6	6	6	6	6	6	2	
		l _{cs} % (1)		50	50	50	50	50	50	50	100	
	Associated fuses, if required if l _{sc} > breaking capacity l _{cu}	230/240 V	aM	A	★	★	★	★	★	★	★	★
			gG	A	★	★	★	★	★	★	★	★
415 V		aM	A	★	★	★	★	125	125	125	315	
		gG	A	★	★	★	★	160	160	160	400	
440 V		aM	A	63	80	125	125	125	125	125	315	
		gG	A	80	100	160	160	160	160	160	400	
500 V		aM	A	63	63	63	63	80	80	80	200	
		gG	A	80	80	80	80	100	100	100	250	
690 V		aM	A	50	50	50	50	63	63	63	200	
		gG	A	63	63	63	63	80	80	80	250	

★ Fuse not required: breaking capacity I_{cn} > I_{sc}.
(1) As % of I_{cu}.

Breaking capacity of GV7 R										
Circuit-breaker type			A	GV7						
				RE20...RE100	RS20...RS100	RE150	RS150	RE220	RS220	
Rating				12...20 to 60...100		90...150	90...150	132...220	132...220	
Breaking capacity conforming to IEC 60947-2	230/240 V	Icu	kA	85	100	85	100	85	100	
		Ics % (1)		100	100	100	100	100	100	
	400/415 V	Icu	kA	36	70	35	70	35	70	
		Ics % (1)		100	100	100	100	100	100	
	440 V	Icu	kA	36	65	35	65	35	65	
		Ics % (1)		100	100	100	100	100	100	
	500 V	Icu	kA	18	50	30	50	30	50	
		Ics % (1)		100	100	100	100	100	100	
	690 V	Icu	kA	8	10	8	10	8	10	
		Ics % (1)		100	100	100	100	100	100	
	Cable protection against thermal stress in the event of short-circuit (PVC insulated copper cables)	Minimum c.s.a. protected at 40 °C at Isc max.	4 mm ²		≤ 6 kA	≤ 6 kA	(2)	(2)	(2)	(2)
			6 mm ²		•	≤ 25 kA	(2)	(2)	(2)	(2)
10...50 mm ²				•	•	•	•	•	•	

(1) As % of Icu.
 • Cable c.s.a. protected.
 (2) Cable c.s.a. not protected.

3

Environment						
Circuit-breaker type		GV2 LE		GV2 L		
Conforming to standards		IEC 60947-1, 60947-2, EN 60204, NF C 63-650, NF C63-120, 79-130, VDE 0113, 0660.				
Product certifications		CSA, CCC		CSA, CCC, BV, DNV, GL, LROS, RINA		
Protective treatment		"TH"		"TH"		
Shock resistance	Conforming to IEC 60068-2-27	30 gn		30 gn		
Vibration resistance	Conforming to IEC 60068-2-6	5 gn (5 to 150 Hz)		5 gn (5 to 150 Hz)		
Ambient air temperature	Storage	°C	- 40...+ 80		- 40...+ 80	
	Operation	°C	- 20...+ 60		- 20...+ 60	
Flame resistance	Conforming to IEC 60695-2-1	°C	960		960	
Maximum operating altitude		m	2000		2000	
Operating position						
Connection (Max. number of conductors x c.s.a)	Solid cable	mm ²	Min. 2 x 1	Max. 2 x 6	Min. 2 x 1	Max. 2 x 6
	Flexible cable without cable end	mm ²	2 x 1.5	2 x 6	2 x 1.5	2 x 6
	Flexible cable with cable end	mm ²	2 x 1	2 x 4	2 x 1	2 x 4
Tightening torque		N.m	1.7		1.7	
Suitable for isolation	Conforming to IEC 60947-1 § 7-1-6	Yes		Yes		
Resistance to mechanical impact		J	0.5		0.5	
Technical characteristics						
Utilisation category	Conforming to IEC 60947-2	A		A		
	Conforming to IEC 60947-4-1	AC-3		AC-3		
Rated operational voltage (U _e)	Conforming to IEC 60947-2	V	690		690	
Rated insulation voltage (U _i)	Conforming to IEC 60947-2	V	690		690	
Rated operational frequency	Conforming to IEC 60947-2	Hz	50/60		50/60	
Rated impulse withstand voltage (U _{imp})	Conforming to IEC 60947-2	kV	6		6	
Total power dissipated per pole		W	1.8		1.8	
Mechanical durability (C.O.: Closing, Opening)	For AC-3 duty	C.O.	100 000		100 000	
Electrical durability for AC-3/415V duty (C.O.: Closing, Opening)		C.O.	100 000		100 000	
Duty class (maximum operating rate)		C.O./h	40		40	
Rated duty	Conforming to IEC 60947-4-1	Continuous duty		Continuous duty		

Circuit-breaker type				GV2 LE										GV2 L												
				03 to 06	07	08	10	14	16	20	22	32	03 to 05	06 & 07	08	10	14	16	20	22	32					
Rating			A	0.4 to 1.6	2.5	4	6.3	10	14	16	18	25	32	0.4 to 1	1.6 to 2.5	4	6.3	10	14	16	18	25	32			
Breaking capacity conforming to IEC 60947-2	230/240 V	l _{cu}	kA	*	*	*	*	*	*	*	*	50	50	*	*	*	*	*	*	*	*	50	50			
		l _{cs} % (1)		*	*	*	*	*	*	*	*	*	100	100	*	*	*	*	*	*	*	*	100	100		
	400/415 V	l _{cu}	kA	*	*	*	*	*	15	15	15	15	10	10	*	*	*	*	*	*	*	50	50	50	50	
		l _{cs} % (1)		*	*	*	*	*	50	50	40	50	50	50	*	*	*	*	*	*	*	50	50	50	50	
	440 V	l _{cu}	kA	*	*	*	50	15	8	8	6	6	6	6	*	*	*	*	*	*	*	20	20	20	20	
		l _{cs} % (1)		*	*	*	100	100	50	50	50	50	50	50	*	*	*	*	*	*	*	75	75	75	75	
	500 V	l _{cu}	kA	*	*	*	50	10	6	6	4	4	4	4	*	*	*	*	*	*	*	10	10	10	10	
		l _{cs} % (1)		*	*	*	100	100	75	75	75	75	75	75	*	*	*	*	*	*	*	100	75	75	75	
	690 V	l _{cu}	kA	*	3	3	3	3	3	3	3	3	3	3	*	4	4	4	4	4	4	4	4	4	4	
		l _{cs} % (1)		*	75	75	75	75	75	75	75	75	75	75	*	100	100	100	100	100	100	100	100	100	100	
	Associated fuses (if required) if I _{sc} > breaking capacity I _{cu} conforming to IEC 60947-2 amendment 1	230/240 V	aM	A	*	*	*	*	*	*	*	*	80	80	*	*	*	*	*	*	*	*	100	100		
			gG	A	*	*	*	*	*	*	*	*	100	100	*	*	*	*	*	*	*	*	*	125	125	
400/415 V		aM	A	*	*	*	*	*	63	63	80	80	80	80	*	*	*	*	*	*	*	80	100	100	100	
		gG	A	*	*	*	*	*	80	80	100	100	100	100	*	*	*	*	*	*	*	100	125	125	125	
440 V		aM	A	*	*	*	50	50	50	50	63	63	63	63	*	*	*	*	*	*	*	50	63	80	80	80
		gG	A	*	*	*	63	63	63	63	80	80	80	80	*	*	*	*	*	*	*	63	80	100	100	100
500 V		aM	A	*	*	*	50	50	50	50	50	50	50	50	*	*	*	*	*	*	*	50	50	50	50	
		gG	A	*	*	*	63	63	63	63	63	63	63	63	*	*	*	*	*	*	*	63	63	63	63	
690 V		aM	A	*	16	25	32	32	40	40	40	40	40	40	*	20	25	40	40	40	40	50	50	50	50	
		gG	A	*	20	32	40	40	50	50	50	50	50	50	*	25	32	50	50	50	50	63	63	63	63	
Cable protection against thermal stress in the event of short-circuit (PVC insulated copper cables) Minimum c.s.a. protected at 40 °C and at I _{sc} max.		1 mm ²	kA	•	•	•	≤10	≤6	(2)	(2)	(2)	(2)	(2)	(2)	•	•	•	•	•	•	•	•	•	•	(2)	
		1.5 mm ²	kA	•	•	•	≤20	≤10	(2)	(2)	(2)	(2)	(2)	(2)	•	•	•	•	•	•	•	•	•	•	(2)	
	2.5 mm ²		•	•	•	•	•	•	•	•	•	•	•	(2)	•	•	•	•	•	•	•	•	•	(2)		
	4...6 mm ²		•	•	•	•	•	•	•	•	•	•	•	•	•	•	•	•	•	•	•	•	•	•		

★ > 100 kA
 • Cable c.s.a. protected
 (1) As % of I_{cu}
 (2) Cable c.s.a. not protected



3

Environment						
Circuit-breaker type			GV3 L		GK3 EF80	
Conforming to standards			IEC/EN 60947-1, 60947-2		IEC 60947-2, EN 60204	
Protective treatment			"TH"		"TC"	
Degree of protection	Conforming to IEC 60529		IP 20		IP 20	
Shock resistance	Conforming to IEC 60068-2-27		On : 15 gn -11 ms Off : 30 gn -11 ms		22 gn -20 ms	
Vibration resistance	Conforming to IEC 60068-2-6		4 gn (5...300 Hz)		2.5 gn (0...25 Hz)	
Flame resistance	Conforming to IEC 60695-2-1	°C	960		960	
Ambient air temperature	Storage	°C	- 40...+ 80		- 40...+ 80	
	Operation	°C	- 20...+ 60 (1)		- 20...+ 70 open mounted	
Maximum operating altitude		m	3000		3000	
Operating position					Any position	
Without derating, in relation to normal vertical mounting plane (2)						
Connection (Max. number of conductors x c.s.a)	Solid cable	mm ²	Min. 2 x 1	Max. 1 x 25 1 x 35	Min. 1 x 2.5	Max. 1 x 35
	Flexible cable without cable end	mm ²	2 x 1	1 x 25 1 x 35	1 x 2.5 or 2 x 2.5	1 x 25 or 2 x 16
	Flexible cable with cable end	mm ²	2 x 1	1 x 25 1 x 35	1 x 2.5 or 2 x 2.5	1 x 25 or 2 x 16
Tightening torque		N.m	5	5 : 25 mm ² 8 : 35 mm ²	5	
Suitable for isolation conforming to IEC 60947-1 § 7-1-6			Yes		Yes	

Technical characteristics						
Rated insulation voltage (Ui)	Conforming to IEC 60947-2	V	690		750	
Rated impulse withstand voltage (U imp)	Conforming to IEC 60947-2	kV	6		10	
Rated operational voltage (Ue)	Conforming to IEC 60947-2	V	690		690	
Rated operational frequency		Hz	50/60		50...60	
Electrical durability for AC-3/415V duty (C.O.: Close - Open)		C.O.	50 000		1500	
Mechanical durability (C.O.: Closing, Opening)		C.O.	50 000		20 000	
Maximum operating rate		C.O./h	25		40	
Operating threshold of magnetic trips			14 I max		3363	
Utilisation category	Conforming to IEC 60947-2		A		A	

(1) Leave a space of 9 mm between 2 circuit-breakers: either an empty space or side-mounting add-on contact blocks. Side by side mounting is possible up to 40 °C.
 (2) When mounting on a vertical rail, fit a stop to prevent any slippage.

Breaking capacity of GV3 L and GK3 EF80										
Type				GV3 L25	GV3 L32	GV3 L40	GV3 L50	GV3 L65	GK3 EF80	
Breaking capacity of the circuit-breaker only or of the circuit-breaker combined with a thermal overload relay	230/240 V	Icu	kA	100	100	100	100	100	50	
		Ics % (1)		100	100	100	100	100	40	
	400/415 V	Icu	kA	100	100	50	50	50	35	
		Ics % (1)		100	100	100	100	100	25	
	440 V	Icu	kA	50	50	50	50	50	25	
		Ics % (1)		100	100	100	100	100	30	
	500 V	Icu	kA	12	12	12	12	12	15	
		Ics % (1)		50	50	50	50	50	30	
	690 V	Icu	kA	6	6	6	6	6	6	
		Ics % (1)		50	50	50	50	50	50	
	Associated fuses (if required) for use with circuit-breaker only or circuit-breaker combined with a thermal overload relay if Isc > breaking capacity	230/240 V	aM	A	★	★	★	★	★	200
			gG	A	★	★	★	★	★	315
415 V		aM	A	★	★	★	★	125	200	
		gG	A	★	★	★	★	160	250	
440 V		aM	A	63	80	125	125	125	160	
		gG	A	80	100	160	160	160	250	
500 V		aM	A	63	63	63	63	80	160	
		gG	A	80	80	80	80	100	200	
690 V		aM	A	50	50	50	50	63	125	
		gG	A	63	63	63	63	80	160	
Use of circuit-breakers without fuses				Minimum cable length (in metres) limiting the maximum short-circuit current to 35 kA maximum, so enabling breakers GK3 EF80 to be used without fuses						
Cable c.s.a.			mm ²	≤ 25	35	50	70	95	120	
Isc (rms) 3-phase, incoming (Ue = 415 V)	50 kA	m	5	6	8	10	13	15		
	45 kA	m	5	5	7	8	10	12		
	40 kA	m	5	5	5	5	8	9		
	37 kA	m	5	5	5	5	5	5		

★ Fuse not required: breaking capacity Icn > Isc.
(1) As % of Icu

TeSys protection components

Thermal-magnetic motor circuit-breakers GV2, GV3 P and GV3 L Auxiliary contacts

3

Type of contacts			Instantaneous auxiliary GV AN, GV AD							Fault signalling GV AD, GV AM11 (1)				Instantaneous auxiliary GV AE			
Rated insulation voltage (Ui) (associated insulation coordination)	Conforming to IEC 60947-1	V	690							690				250 (690 in relation to main circuit)			
	Conforming to CSA C22-2 n° 14 and UL 508	V	600							300				300			
Conventional thermal current (Ith)	Conforming to IEC 60947-5-1	A	6							2.5				2.5			
	Conforming to CSA C22-2 n° 14 and UL 508	A	5							1				1			
Mechanical durability (C.O.: Close - Open)		C.O.	100 000							1000				100 000			
Operational power and current conforming to IEC 60947-5-1. a.c. operation			AC-15/100 000 C.O.							AC-14/1000 C.O.				AC-15/100 000 C.O.			
	Rated operational voltage (Ue)	V	48	110	230	380	440	500	690	24	48	110	230	24	48	110	230
	Operational power, normal conditions	VA	300	500	720	850	650	500	400	36	48	72	72	48	60	120	120
	Occasional breaking and making capacities, abnormal conditions	kVA	3	7	13	15	13	12	9	0.22	0.3	0.45	0.45	0.48	0.6	1.27	2.4
	Rated operational current (Ie)	A	6	4.5	3.3	2.2	1.5	1	0.6	1.5	1	0.5	0.3	2	1.25	1	0.5
Operational power and current conforming to IEC 60947-5-1. d.c. operation			DC-13/100 000 C.O.							DC-13/1000 C.O.				DC-13/100 000 C.O.			
	Rated operational voltage (Ue)	V	24	48	60	110	240	–	–	24	48	60	–	24	48	60	–
	Operational power, normal conditions	W	140	240	180	140	120	–	–	24	15	9	–	24	15	9	–
	Occasional breaking and making capacities, abnormal conditions	W	240	360	240	210	180	–	–	100	50	50	–	100	50	50	–
	Rated operational current (Ie)	A	6	5	3	1.3	0.5	–	–	1	0.3	0.15	–	1	0.3	0.15	–
Low power switching reliability of contact			GV AE: Number of failures for "n" million operating cycles (17 V-5 mA); = 10 ⁻⁶														
Minimum operational conditions d.c. operation		V	17														
		mA	5														
Short-circuit protection			By GB2 CB●● circuit-breaker (rating according to operational current for Ue ≤ 415 V) or by gG fuse 10 A max										GB2 CB06 or gG fuse 10 A max				
Cabling, screw clamp terminals	Number of conductors		1			2											
	Solid cable	mm ²	1...2.5			1...2.5											
	Flexible cable without cable end	mm ²	0.75...2.5			0.75...2.5											
	Flexible cable with cable end	mm ²	0.75...1.5			0.75...1.5											
	Tightening torque	N.m	1.4 max			1.4 max											
Cabling, spring terminal connections	Flexible cable without cable end	mm ²	GV AN only 0.75...2.5			0.75...2.5				–				0.75...1.5			

Operation of instantaneous auxiliary contacts

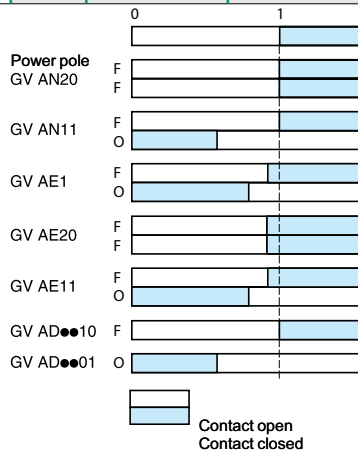

Operation of fault signalling contacts

GV AM11
Change of state following tripping on
short-circuit.

GV AD10●● and GV AD01●●
Change of state following tripping on
short-circuit, overload or undervoltage.

(1) For application example of fault signalling contact and short-circuit signalling contact, see page 3/76.
(2) Add an RC circuit type LA4 D to the load terminals, see page 5/81.

TeSys protection components

Thermal-magnetic motor circuit-breakers

GV3 ME80

Auxiliary contacts

Type of contacts			Instantaneous auxiliary contacts GV3 A01...A07							Fault signalling contacts GV3 A08 and A09						
Rated insulation voltage (Ui)	Conforming to IEC 60947-1	V	690							690						
	Conforming to CSA C22-2 n° 14, UL 508	V	600 (B600)							600 (B600)						
Conventional rated thermal current (Ith)	Conforming to IEC 60947-5-1	A	6							6						
	Conforming to CSA C22-2 n° 14, UL 508	A	5 (B600)							5 (B600)						
Mechanical durability (C.O.: Close - Open)		C.O.	100 000							1000						
Operational power and current conforming to IEC 60947-5-1 a.c. operation	Rated operational voltage (Ue)	V	48	110	220	380	440	500	690	48	110	220	380	440	500	690
	Operational power	VA	350	500	800	850	700	700	400	240	460	800	850	450	450	200
	Occasional breaking and making capacities	kVA	4	12	20	20	15	15	10	2.4	8	12	15	12	12	8
	Operational current (Ie)	A	6	4.5	3.5	2.2	1.5	1.5	0.6	5	3.6	3.5	2.2	1	1	0.3
Operational power and current conforming to IEC 60947-5-1 d.c. operation	Rated operational voltage (Ue)	V	24 48 60 110 220							24 48 60 110 220						
	Operational power	W	DC-11/100 000 C.O.							DC-11/1000 C.O.						
	Occasional breaking and making capacities	W	180	240	180	140	120	120	120	90	70	60				
	Operational current (Ie)	A	6	5	3	1.3	0.5	5	2.5	1.5	0.7	0.3				
Short-circuit protection			By GB2 CB08 circuit-breaker or gG fuse, 6A max													
Connection	Number of conductors		1			2										
	Solid cable	mm²	1...2.5			1...2.5										
	Flexible cable without cable end	mm²	0.75...2.5			0.75...2.5										
	Flexible cable with cable end	mm²	0.75...2.5			0.75...1.5										

3

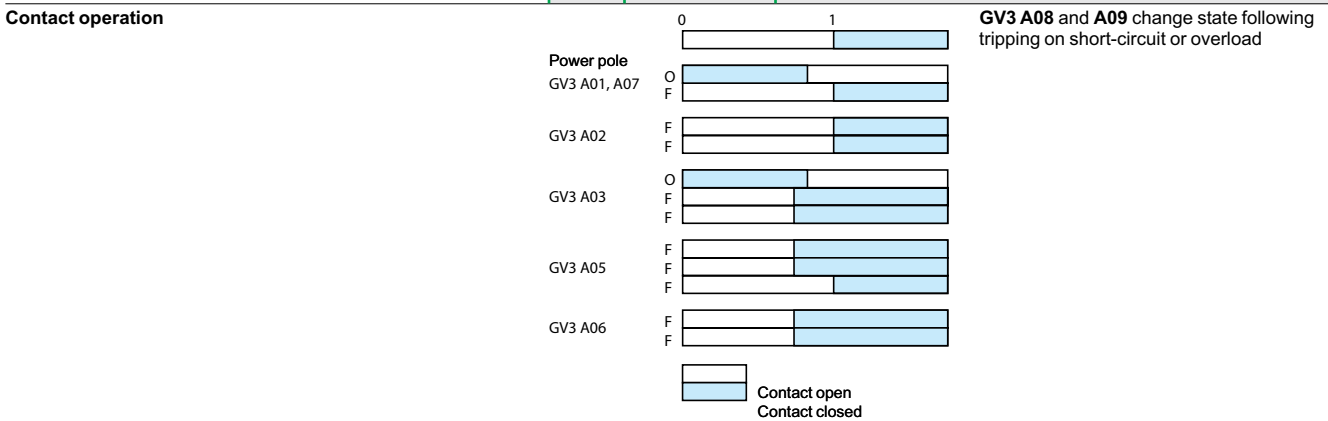

3

Auxiliary contact characteristics																	
Type of contacts			GV7 AE11							GV7 AB11							
Rated insulation voltage (Ui) (associated insulation coordination)	Conforming to IEC 60947-1	V	690							690							
Conventional thermal current (Ith)	Conforming to IEC 60947-5-1	A	6							6							
Mechanical durability (C.O.: Close - Open)		C.O.	50 000							50 000							
Operational current conforming to IEC 60947-5-1 a.c. operation	Rated operational voltage (Ue)	V	AC-12 or AC-15. 50 000 C.O.							AC-12 or AC-15. 50 000 C.O.							
	Rated operational current (Ie)	AC-12	A	6	6	6	6	6	6	6	5	5	5	5	5	5	5
		AC-15	A	6	6	5	4	3	3	0.1	5	5	4	3	2.5	2.5	0.1
Operational current conforming to IEC 60947-5-1 d.c. operation	Rated operational voltage (Ue)	V	DC-12 or DC-14. 50 000 C.O.							DC-12 or DC-14. 50 000 C.O.							
	Rated operational current (Ie)	DC-12	A	2.5	2.5	0.8	0.3	2	2	0.5	–						
		DC-14	A	1	0.2	0.5	0.03	0.5	0.1	0.25	–						
Minimum operational conditions d.c. operation		V	17							12							
		mA	5							5							
Short-circuit protection			By GB2 CB●● circuit-breaker (rating according to operational current for Ue ≤ 415 V) or gG fuse, 10 A max.														
Cabling	Solid cable	mm ²	1 x 1.5 conductor							1 x 1.5 conductor							
	Flexible cable without cable end	mm ²	1 x 1.5 conductor							1 x 1.5 conductor							
	Flexible cable with cable end	mm ²	1 x 1.5 conductor							1 x 1.5 conductor							

Characteristics of Start-Stop and fault signalling contacts

Rated insulation voltage (Ui)	Conforming to IEC 60947-1	V	500					
Rated operational voltage (Ue)	Conforming to IEC 60947-1	V	500					
Conventional thermal current (Ith)	Conforming to IEC 60947-5-1	A	6					
Operational power and current conforming to IEC 60947-5-1 a.c. operation (C.O.: Close - Open)	Rated operational voltage (Ue)	V	AC-15. 20 000 C.O.					
	Operational power	VA	48	110/127	220/240	380/415	440	500
	Occasional breaking and making capacities	VA	4000	12 000	20 000	20 000	15 000	15 000
	Rated operational current (Ie)	A	6	4.5	3.5	2.2	1.5	1.5
Operational power and current conforming to IEC 60947-5-1 d.c. operation (C.O.: Close - Open)	Rated operational voltage (Ue)	V	DC-13. 1000 C.O.					
	Operational power	W	24	48	60	110	220	
	Occasional breaking and making capacities	W	240	280	240	210	180	
	Rated operational current (Ie)	A	6	5	3	1.3	0.5	
Short-circuit protection	Conforming to IEC 60947-5-1		By GB2 CB08 circuit-breaker or gG fuse, 6A max					
Cabling	Solid cable	mm²	1 x 1...4 conductor					
	Flexible cable without cable end	mm²	1 x 2.5 conductor					
	Flexible cable with cable end	mm²	1 x 1...2.5 conductor or 2 x 1...2.5 conductors					
Tightening torque		N.m	0.8					

3

Characteristics of electric trips									
Circuit-breaker type			GV2 ME, GV2 P GV3 P, GV3 L		GV2 ME only	GV3 ME80		GV7 R	
Type of trip			GV AU	GV AS	GV AX (1)	GV3 B	GV3 D	GV7 AU	GV7 AS
Rated insulation voltage (Ui)	Conforming to IEC 60947-1	V	690	690	500	690	690	690	690
	Conforming to CSA C22-2 n° 14, UL 508	V	600	600	–	600 (B600)	600 (B600)	600	600
Operational voltage	Conforming to IEC 60947-1	V	0.85... 1.1 Un	0.7... 1.1 Un	0.85... 1.1 Un	0.8...1.1 Un		0.85... 1.1 Un	0.7... 1.1 Un
Drop-out voltage		V	0.7... 0.35 Un	0.75... 0.2 Un	0.7... 0.35 Un	0.7...0.35 Un		0.35... 0.7 Ue	0.2... 0.75 Ue
Inrush consumption	~	VA	12	14	12	12		< 10	
	≡	W	8	10.5	8	7		< 5	
Sealed consumption	~	VA	3.5	5	3.5	7		< 5	
	≡	W	1.1	1.6	1.1	2.5		< 5	
Operating time	Conforming to IEC 60947-1	ms	From the moment the voltage reaches its operational value until opening of the circuit-breaker. 10...15			10	15	< 50	
On-load factor			100 %			100 %		100 %	
Cabling	Number of conductors		2 or 4			1 or 2		1	
	Solid cable	mm ²	1...2.5			1...2.5		1.5	
	Flexible cable without cable end	mm ²	0.75...2.5			0.75...2.5		1.5	
	Flexible cable with cable end	mm ²	0.75...1.5			0.75...2.5		1	
Tightening torque		N.m	1.4 max			1.2		1.2	
Mechanical durability (C.O.: Close - Open)		C.O.	30 000 (GV2 ME and GV2 P) 10 000 (GV3 P and GV3 L)			50 % of the mechanical durability of the circuit-breaker			

(1) Wiring scheme of undervoltage trip for dangerous machines (conforming to INRS) on **GV2 ME** only, see page 3/76.

Characteristics of 3-pole busbars GV2 G●●● and GV3 G●64

			GV2 G●●●	GV3 G●64
Rated insulation voltage (Ui)	Conforming to IEC 60947-1	V	690	690
Conventional thermal current (Ith)	Conforming to IEC 60439-1	A	63	115
Permissible peak current (I peak)		kA	11	20
Permissible thermal limit (I²t)		kA²s	104	300
Degree of protection	Conforming to IEC 60529		IP 20	IP 20
Terminal block			Yes	–

Characteristics of terminal blocks GV2 G05 and GV1 G09 (for GV2 ME and GV2 P)

Rated insulation voltage (Ui)	Conforming to IEC 60947-1	V	690
Conventional thermal current (Ith)	Conforming to IEC 60439-1	A	63
Degree of protection	Conforming to IEC 60529		IP 20
Connection	Solid cable	mm²	1 x 1.5 to 25 conductor or 2 x 1.5 to 6 conductors
	Flexible cable without cable end	mm²	1 x 1.5 to 16 conductor or 2 x 2.5 to 4 conductors
	Flexible cable with cable end	mm²	1 x 1.5 to 10 conductor or 2 x 1.5 to 2 conductors
	Flexible or solid cable AWG		1 AWG 4
Tightening torque	Connector	N.m	2.2
	Screw clamp terminals	N.m	1.7

Characteristics of current limiters (GV2 ME and GV2 P)

Type			GV1 L3		LA9 LB920	
Rated insulation voltage (Ui)	Conforming to IEC 60947-1	V	690		690	
Conventional thermal current (Ith)	Conforming to IEC 60947-1	A	63		63	
Operating threshold	rms current	A	1500 (non adjustable threshold)		1000 (non adjustable threshold)	
Connection			1 conductor	2 conductors	1 conductor	2 conductors
	Solid cable	mm²	1.5...25	1.5...10	1.5...25	1.5...10
	Flexible cable without cable end	mm²	1.5...25	2.5...10	1.5...25	1.5...10
	Flexible cable with cable end	mm²	1.5...16	1.5...4	1.5...16	1.5...4
Tightening torque		N.m	2.2			

Thermal-magnetic tripping curves for GV2 ME and GV2 P

Average operating times at 20 °C related to multiples of the setting current

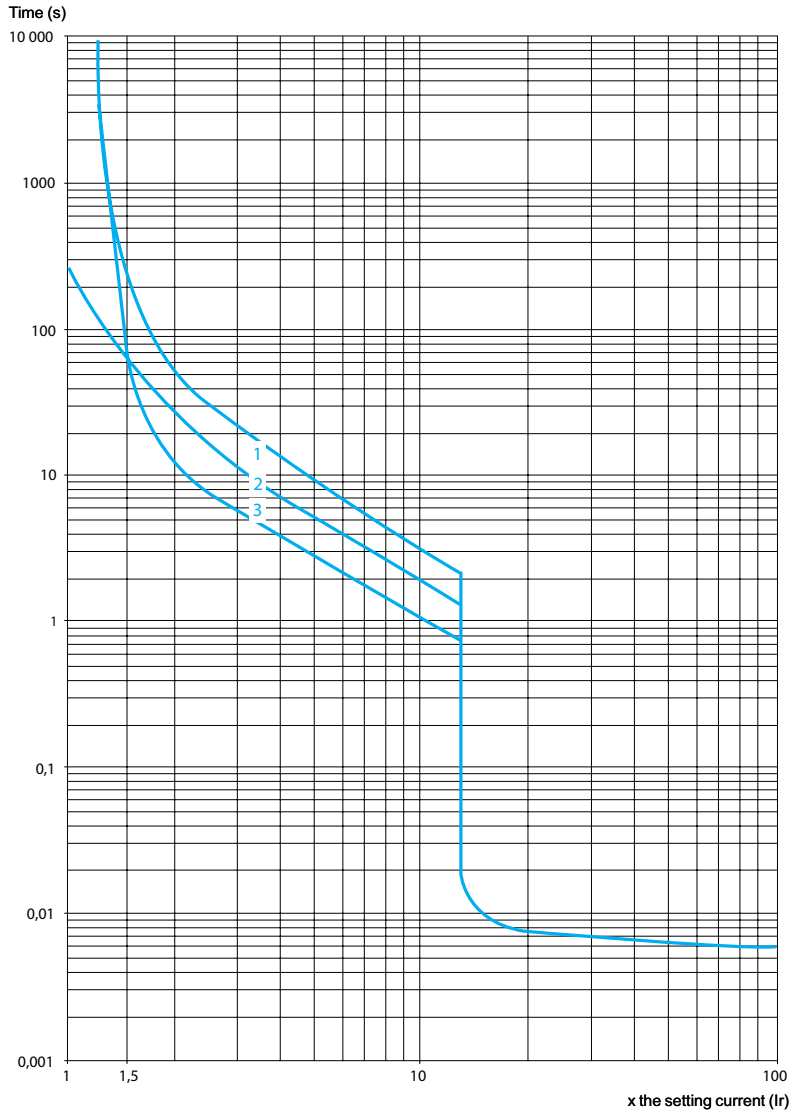

- 1 3 poles from cold state
- 2 2 poles from cold state
- 3 3 poles from hot state

Current limitation on short-circuit for GV2 ME and GV2 P (3-phase 400/415 V)

Dynamic stress

$I_{peak} = f(\text{prospective } I_{sc}) \text{ at } 1.05 U_e = 435 \text{ V}$

Limited peak current (kA)

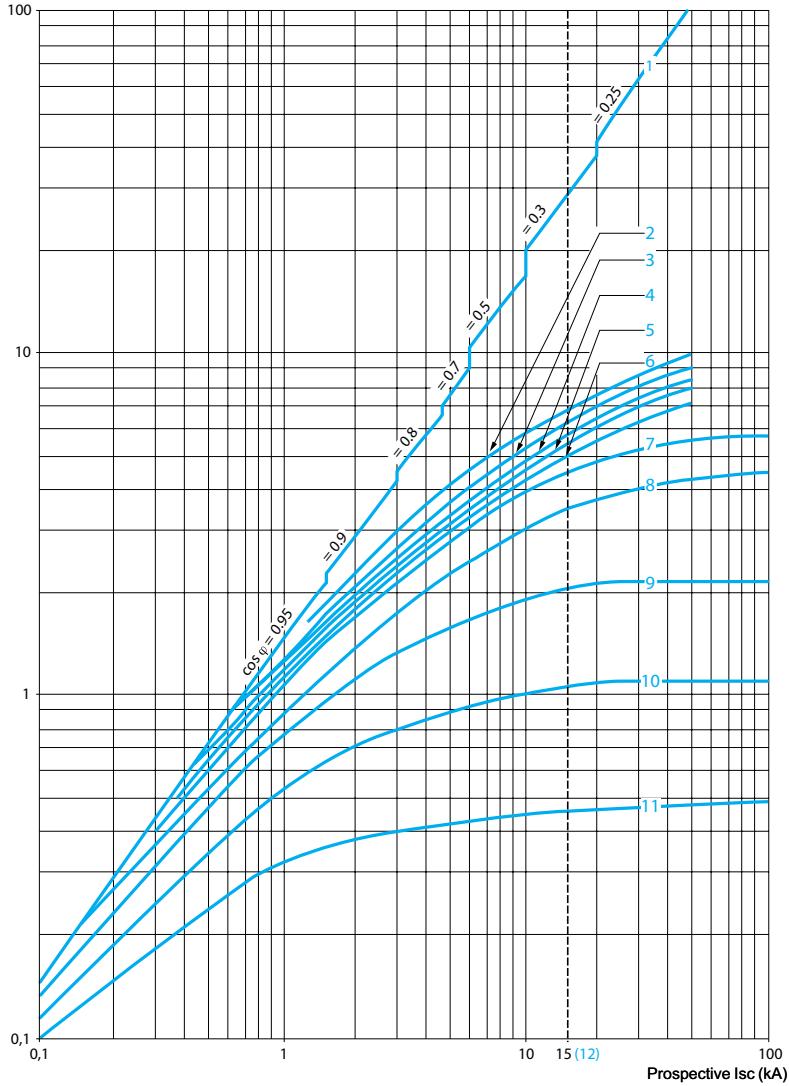

- 1 Maximum peak current
- 2 24 -32 A
- 3 20 -25 A
- 4 17 -23 A
- 5 13 -18 A
- 6 9 -14 A
- 7 6 -10 A
- 8 4 -6.3 A
- 9 2.5 -4 A
- 10 1.6 -2.5 A
- 11 1 -1.6 A
- 12 Limit of rated ultimate breaking capacity on short-circuit of GV2 ME (14, 18, 23 and 25 A ratings)

Thermal limit on short-circuit for GV2 ME

Thermal limit in kA²s in the magnetic operating zone

Sum of I²dt = f (prospective I_{sc}) at 1.05 U_e = 435 V

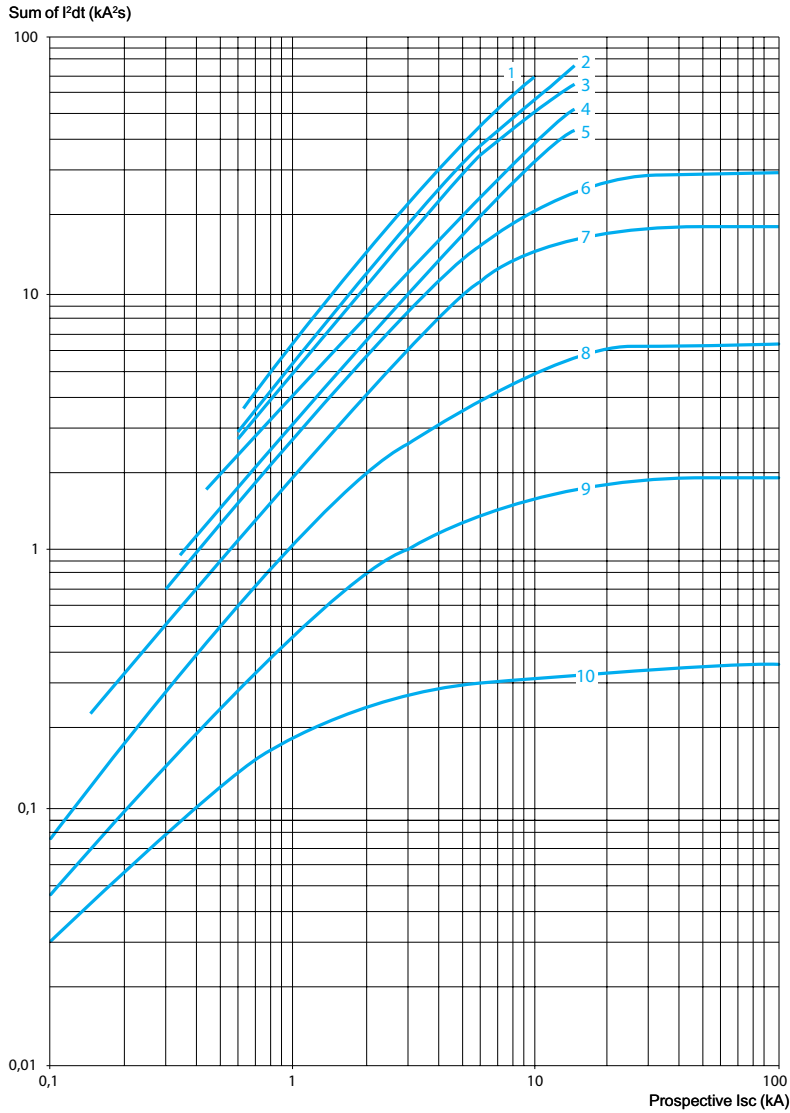

- 1 24 -32 A
- 2 20 -25 A
- 3 17 -23 A
- 4 13 -18 A
- 5 9 -14 A
- 6 6 -10 A
- 7 4 -6.3 A
- 8 2.5 -4 A
- 9 1.6 -2.5 A
- 10 1 -1.6 A

Thermal limit on short-circuit for GV2 P

Thermal limit in kA^2s in the magnetic operating zone

Sum of $I^2dt = f$ (prospective I_{sc}) at 1.05 $U_e = 435 V$

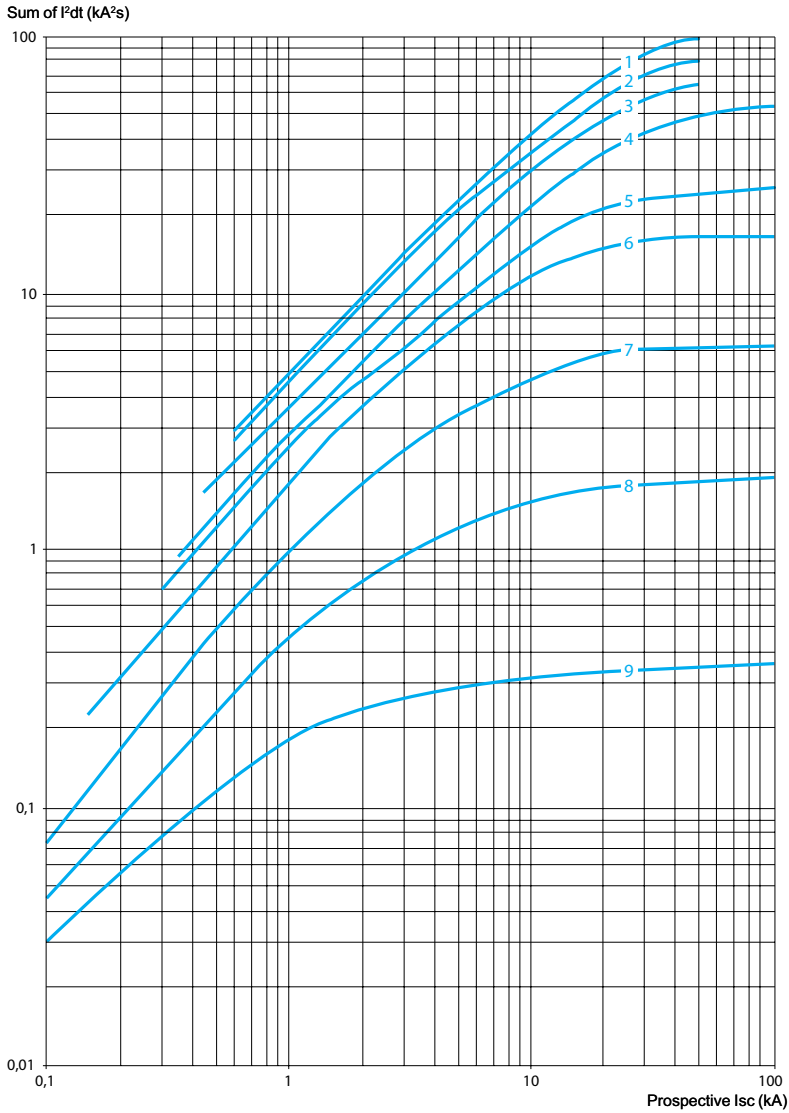

- 1 24 -32 A
- 1 20 -25 A
- 2 17 -23 A
- 3 13 -18 A
- 4 9 -14 A
- 5 6 -10 A
- 6 4 -6.3 A
- 7 2.5 -4 A
- 8 1.6 -2.5 A
- 9 1 -1.6 A

Thermal-magnetic tripping curves

Average operating times at 20 °C related to multiples of the setting current

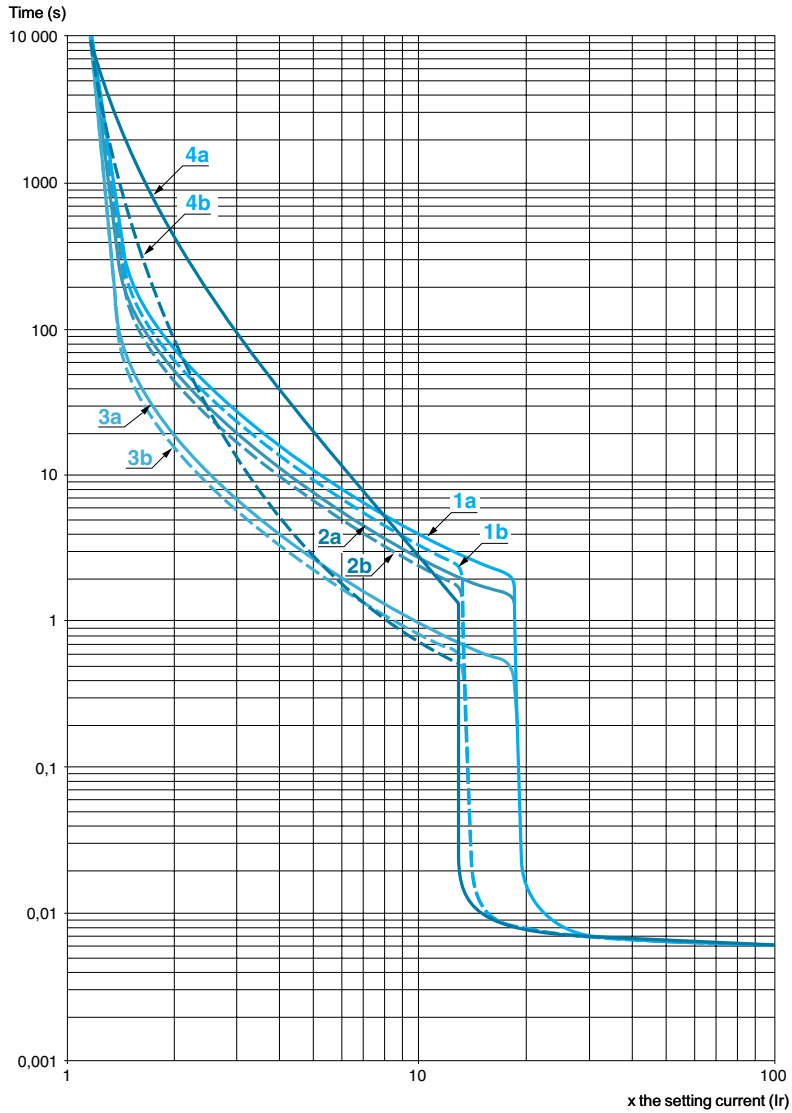

- 1a 3 poles from cold state (Ir mini.) : GV3 P
- 1b 3 poles from cold state (Ir maxi.) : GV3 P
- 2a 2 poles from cold state (Ir mini.) : GV3 P
- 2b 2 poles from cold state (Ir maxi.) : GV3 P
- 3a 3 poles from hot state (Ir mini.) : GV3 P
- 3b 3 poles from hot state (Ir maxi.) : GV3 P
- 4a 3 poles from hot state (Ir mini.) : GV3 ME80
- 4b 3 poles from hot state (Ir maxi.) : GV3 ME80

Current limitation on short-circuit (3-phase 400/415 V)

Dynamic stress

$I_{peak} = f(\text{prospective } I_{sc}) \text{ at } 1.05 U_e = 435 \text{ V}$

Limited peak current (kA)

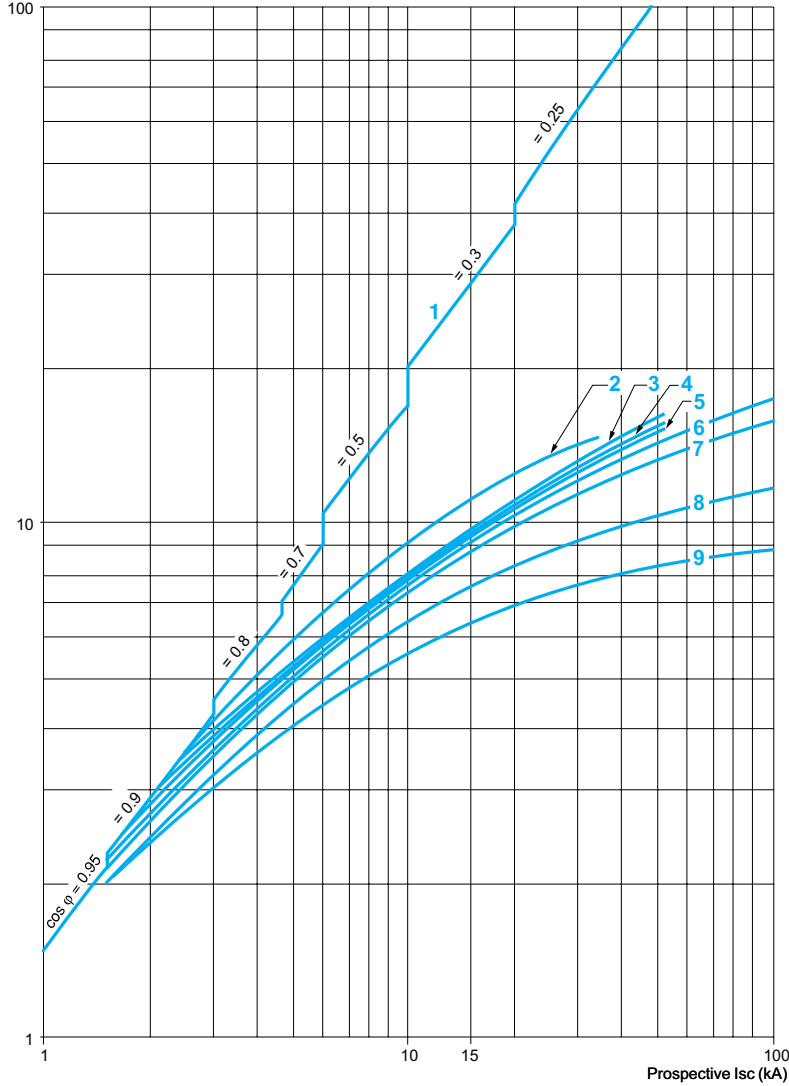

- 1 Maximum peak current
- 2 56-80 A
- 3 48-65 A
- 4 37-50 A
- 5 30-40 A
- 6 23-32 A
- 7 17-25 A
- 8 12-18 A
- 9 9-13 A

Maximum thermal limit on short-circuit

Thermal limit in kA²s in the magnetic operating zone

Sum of $I^2dt = f$ (prospective I_{sc}) at 1.05 $U_e = 435$ V

Sum of I^2dt (kA²s)

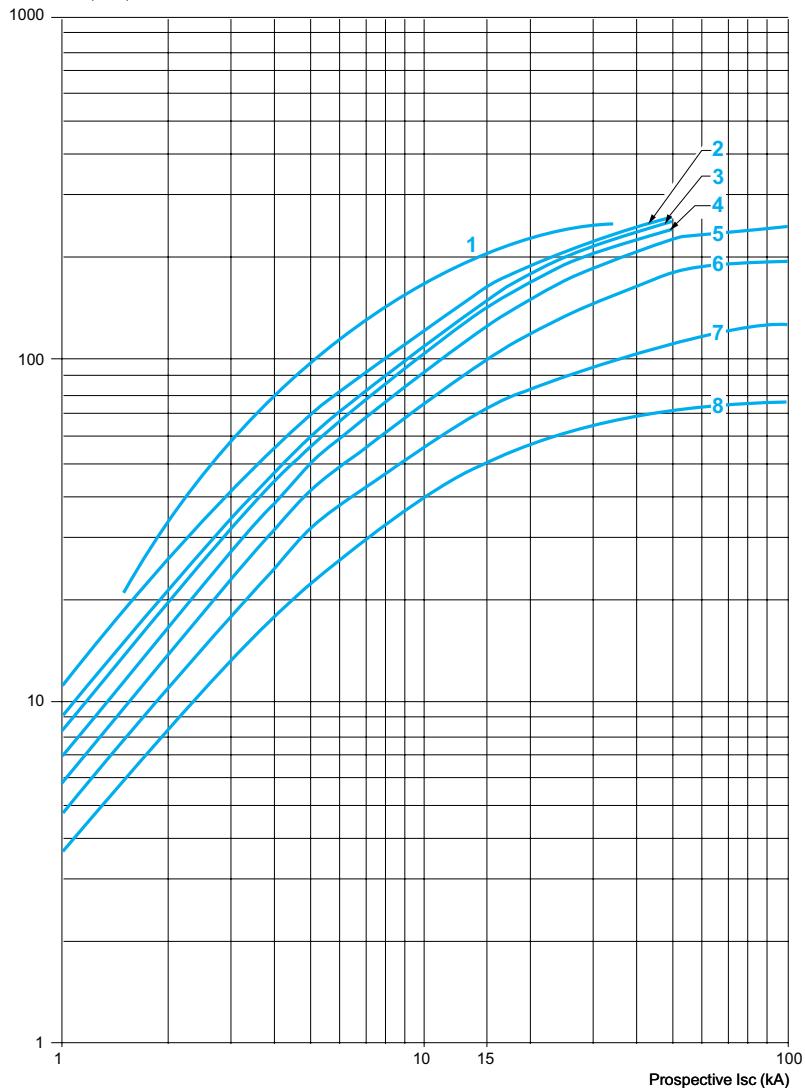

- 1 56-80 A (GV3 ME80)
- 2 48-65 A (GV3 P65)
- 3 37-50 A (GV3 P50)
- 4 30-40 A (GV3 P40)
- 5 23-32 A (GV3 P32)
- 6 17-25 A (GV3 P25)
- 7 12-18 A (GV3 P18)
- 8 9-13 A (GV3 P13)

Thermal-magnetic tripping curves for GV7 R

Average operating times at 20 °C related to multiples of the setting current

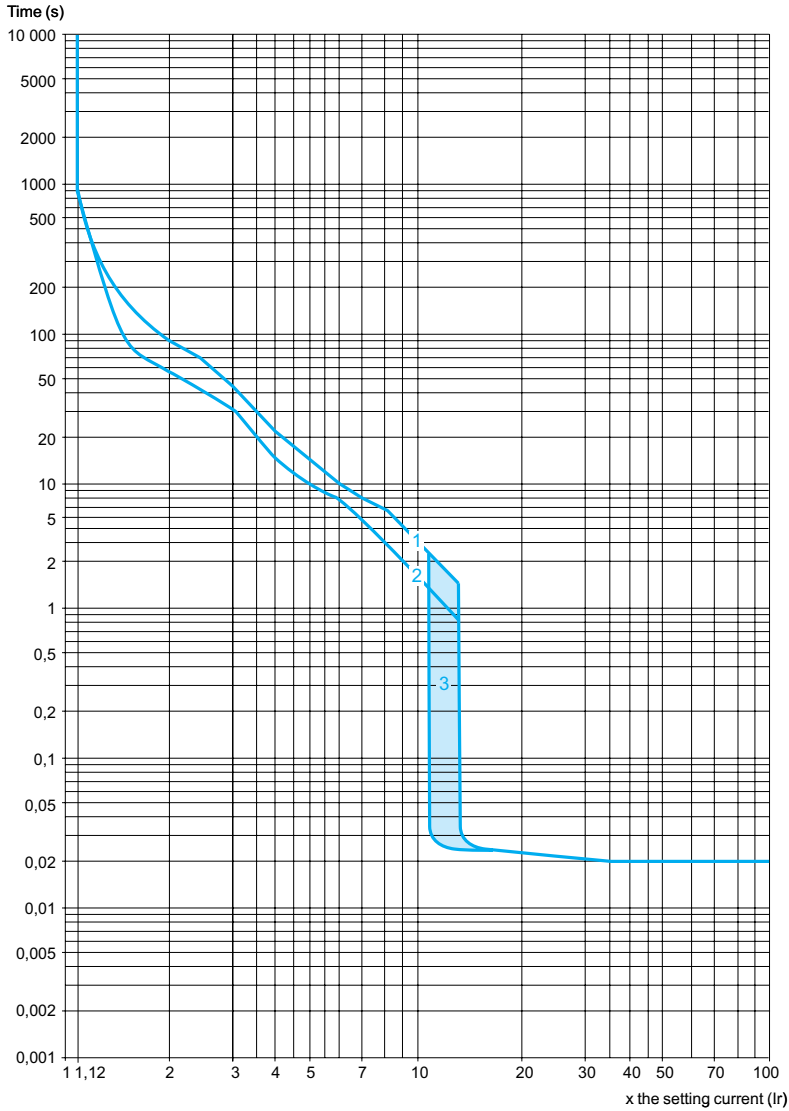

- 1 Cold state curve
- 2 Cold state curve
- 3 12...14 Ir

In the event of total phase failure, tripping occurs after 4 s ± 20 %

Current limitation on short-circuit (3-phase 400/415 V)

Dynamic stress

$I_{peak} = f(\text{prospective } I_{sc})$

For GV7 RE only

Limited peak current (kA)

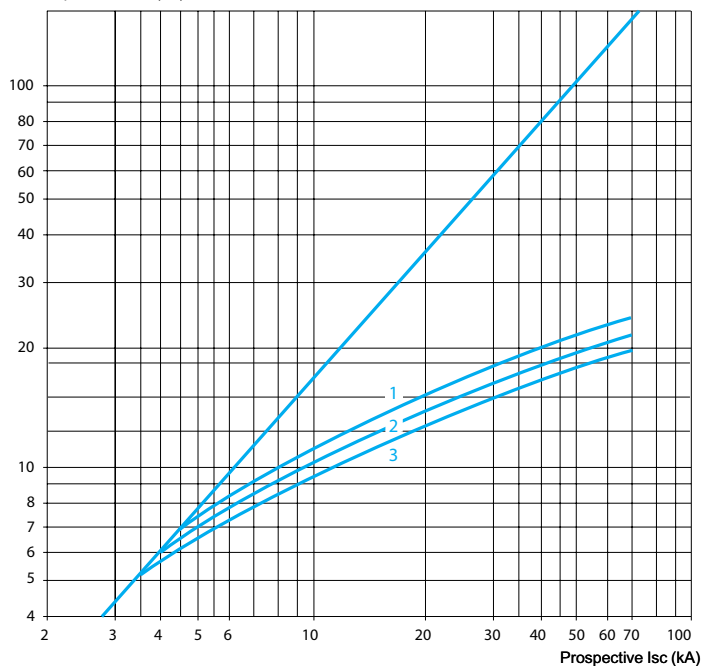

- 1 GV7 RE220
- 2 GV7 RE150
- 3 GV7 RE100

For GV7 RS only

Limited peak current (kA)

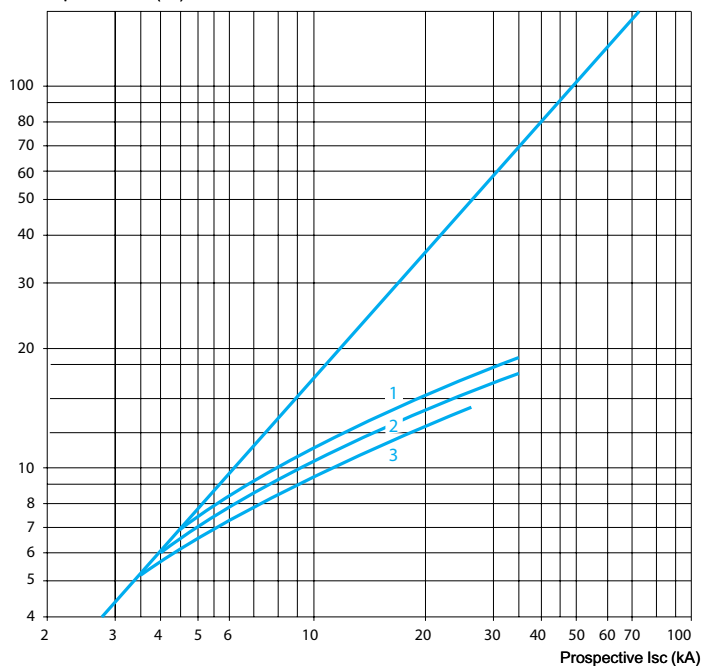

- 1 GV7 RS220
- 2 GV7 RS150
- 3 GV7 RS100

Thermal limit (3-phase 400/415 V)

Thermal limit

Sum of $I^2dt = f$ (prospective I_{sc})

For GV7 RE only

Sum of I^2dt (A²s)

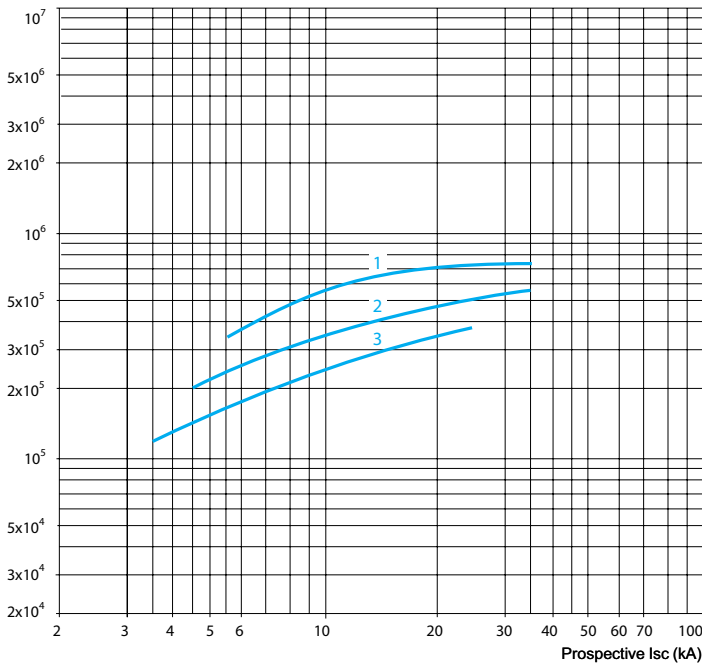

- 1 GV7 RE220
- 2 GV7 RE150
- 3 GV7 RE100

For GV7 RS only

Sum of I^2dt (A²s)

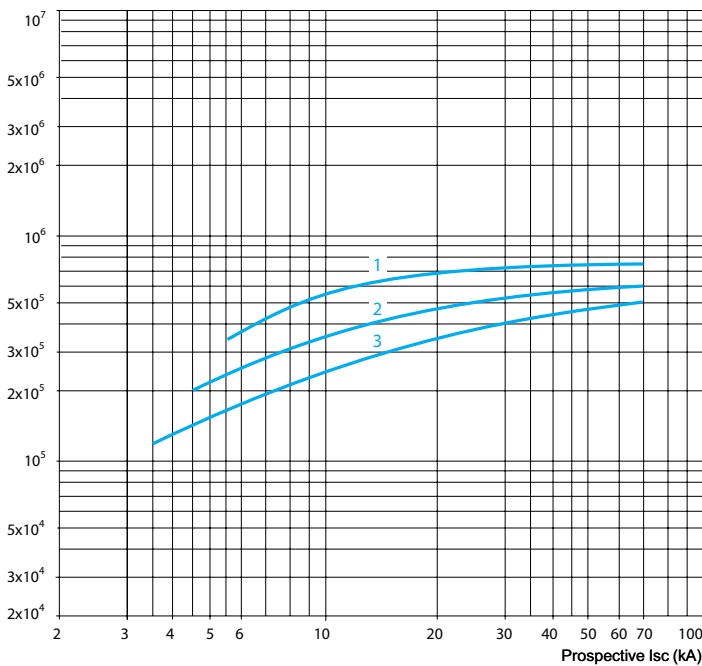

- 1 GV7 RS220
- 2 GV7 RS150
- 3 GV7 RS100

Current limitation on short-circuit (3-phase 690 V)

Dynamic stress

$I_{peak} = f(\text{prospective } I_{sc})$

For GV7 RE only

Limited peak current (kA)

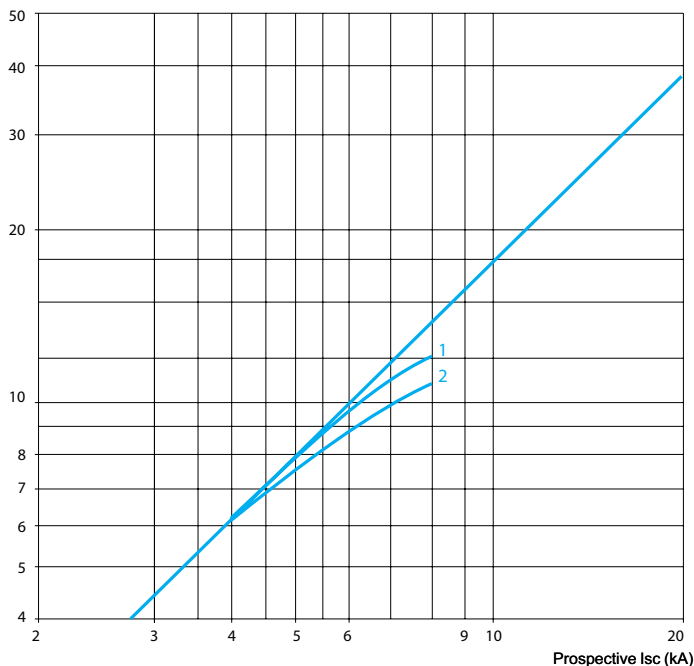

- 1 GV7 RE220
- 2 GV7 RE150 and GV7 RE100

For GV7 RS only

Limited peak current (kA)

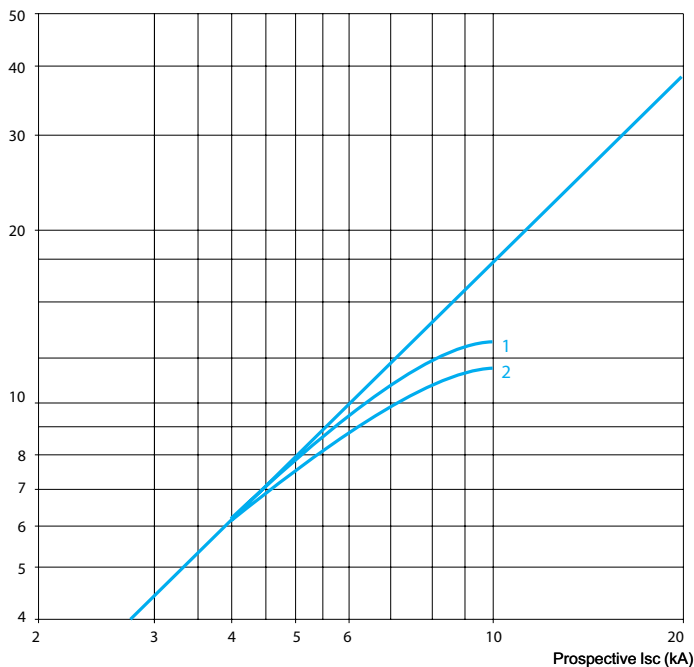

- 1 GV7 RS220
- 2 GV7 RS150 and GV7 RS100

Thermal limit on short-circuit (3-phase 690 V)

Thermal limit

Sum of $I^2dt = f$ (prospective I_{sc})

For GV7 RE only

Sum of I^2dt (A²s)

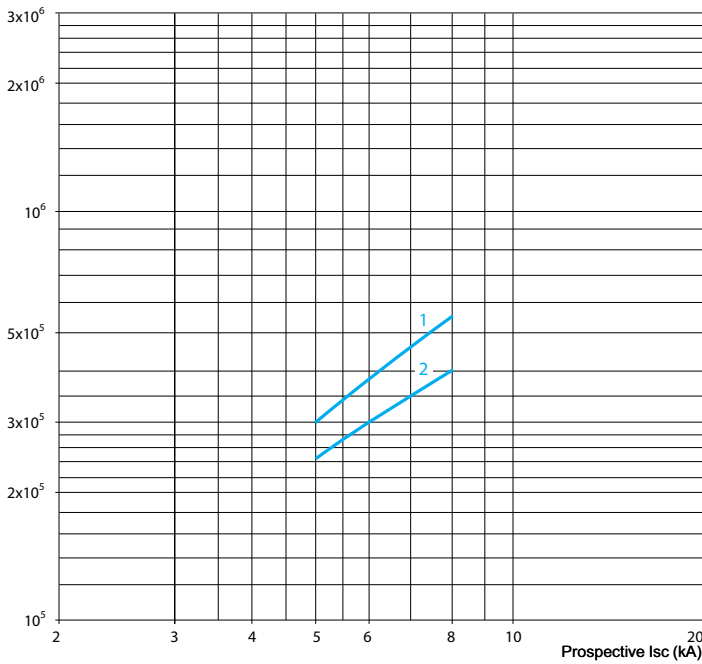

- 1 GV7 RE220
- 2 GV7 RE150 and GV7 RE100

For GV7 RS only

Sum of I^2dt (A²s)

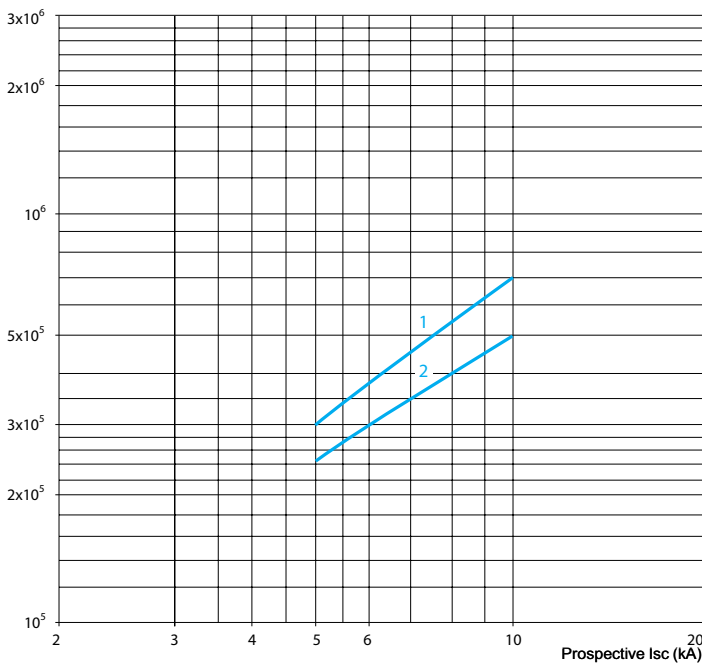

- 1 GV7 RS220
- 2 GV7 RS150 and GV7 RS100

Thermal-magnetic tripping curves for GV2 RT

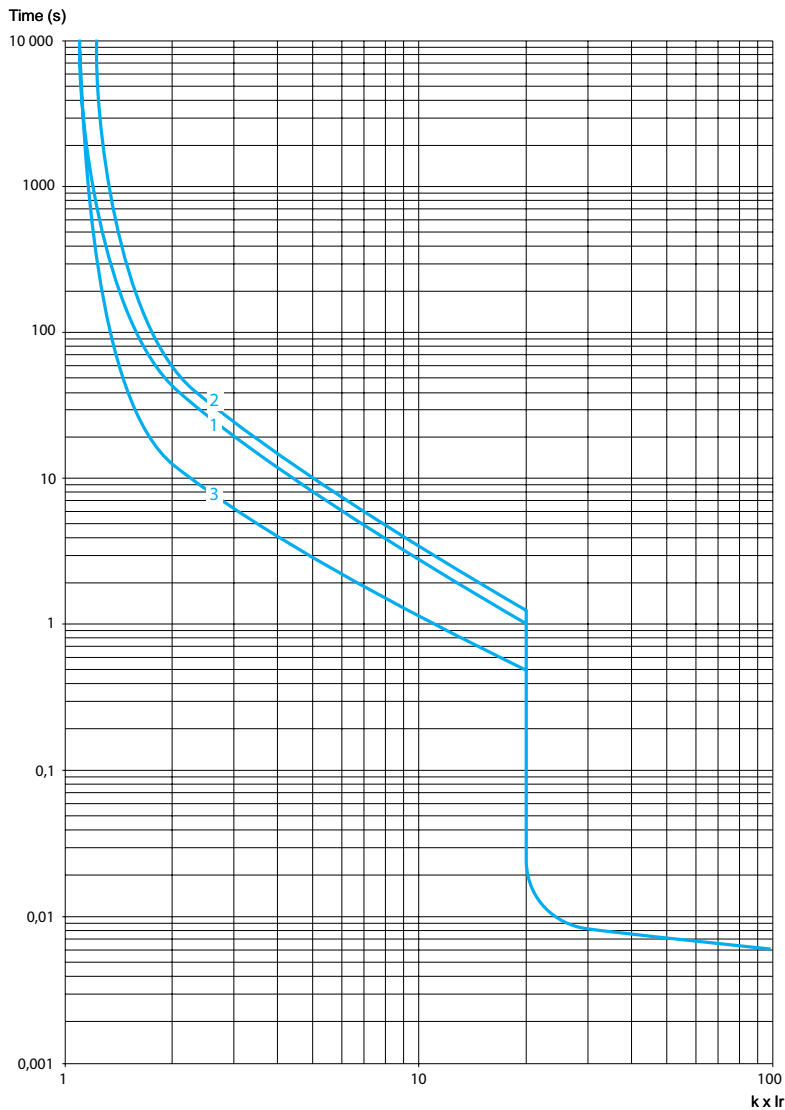

- 1 3 poles from cold state
- 2 2 poles from cold state
- 3 3 poles from hot state

Tripping curves for GV2 L or LE combined with thermal overload relay LRD or LR2 K

Average operating times at 20 °C related to multiples of the setting current

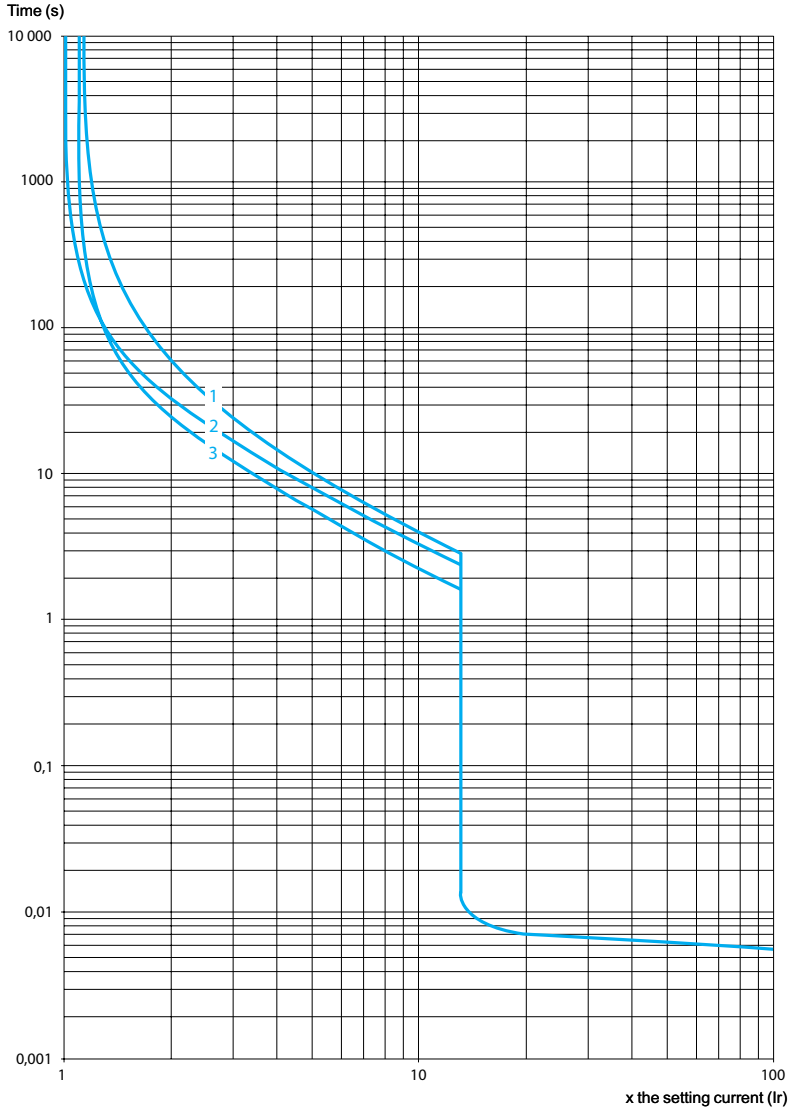

- 1 3 poles from cold state
- 2 2 poles from cold state
- 3 3 poles from hot state

Current limitation on short-circuit for GV2 L and GV2 LE only (3-phase 400/415 V)

Dynamic stress

$I_{peak} = f(\text{prospective } I_{sc}) \text{ at } 1.05 U_e = 435 \text{ V}$

Limited peak current (kA)

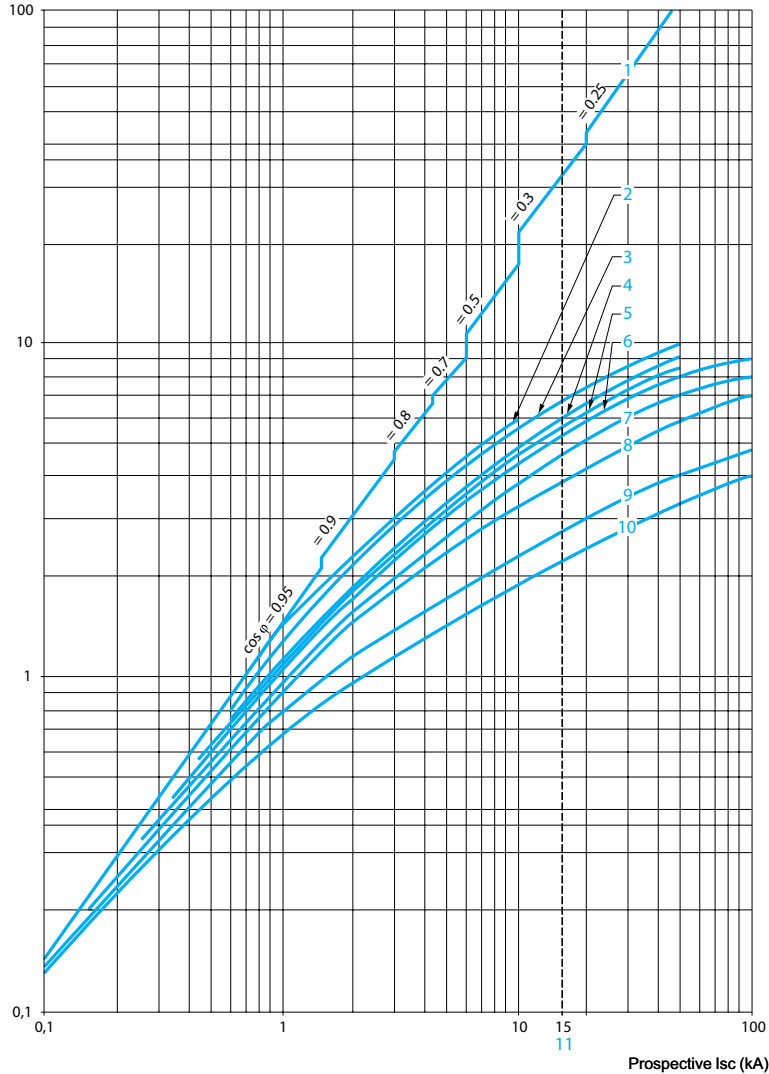

1 Maximum peak current

2 32 A

3 25 A

4 18 A

5 14 A

6 10 A

7 6.3 A

8 4 A

9 2.5 A

10 1.6 A

11 Limit of rated ultimate breaking capacity on short-circuit of GV2 LE (14, 18, 23 and 25 A ratings).

Current limitation on short-circuit for GV2 L and GV2 LE + thermal overload relay LRD or LR2 K (3-phase 400/415 V)
Dynamic stress

$I_{peak} = f(\text{prospective } I_{sc}) \text{ at } 1.05 U_e = 435 \text{ V}$

Limited peak current (kA)

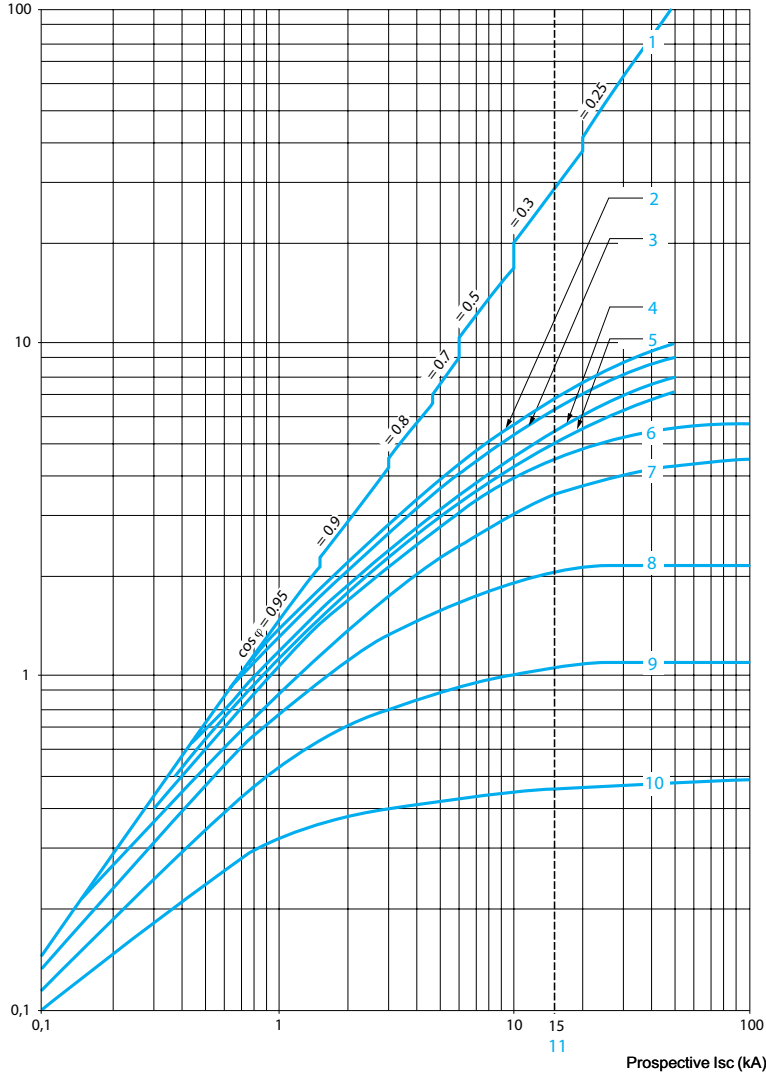

1 Maximum peak current

2 32 A

3 25 A

4 18 A

5 14 A

6 10 A

7 6.3 A

8 4 A

9 2.5 A

10 1.6 A

11 Limit of rated ultimate breaking capacity on short-circuit of GV2 LE (14, 18, 23 and 25 A ratings).

Thermal limit on short-circuit for GV2 LE only

Thermal limit in kA²s in the magnetic operating zone

Sum of I²dt = f (prospective I_{sc}) at 1.05 U_e = 435 V

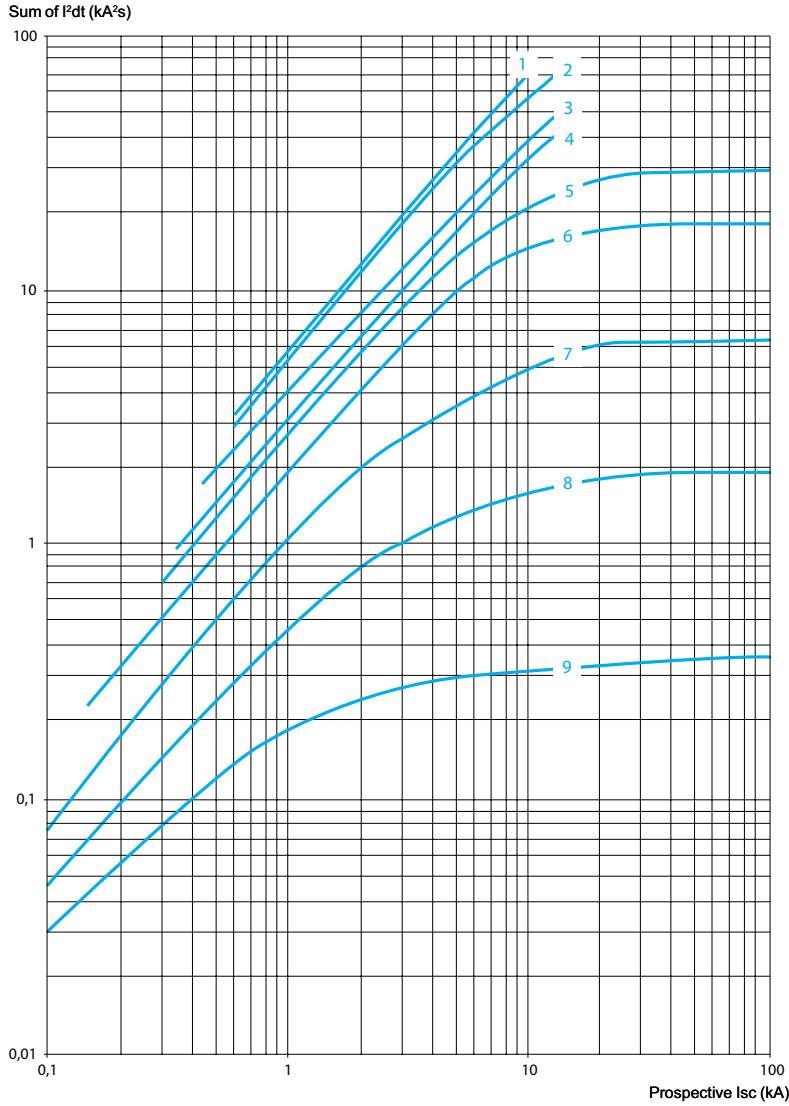

- 1 32 A
- 2 25 A
- 3 18 A
- 4 14 A
- 5 10 A
- 6 6.3 A
- 7 4 A
- 8 2.5 A
- 9 1.6 A

Thermal limit on short-circuit for GV2 L only

Thermal limit in kA²s in the magnetic operating zone

Sum of I²dt = f (prospective I_{sc}) at 1.05 U_e = 435 V

Sum of I²dt (kA²s)

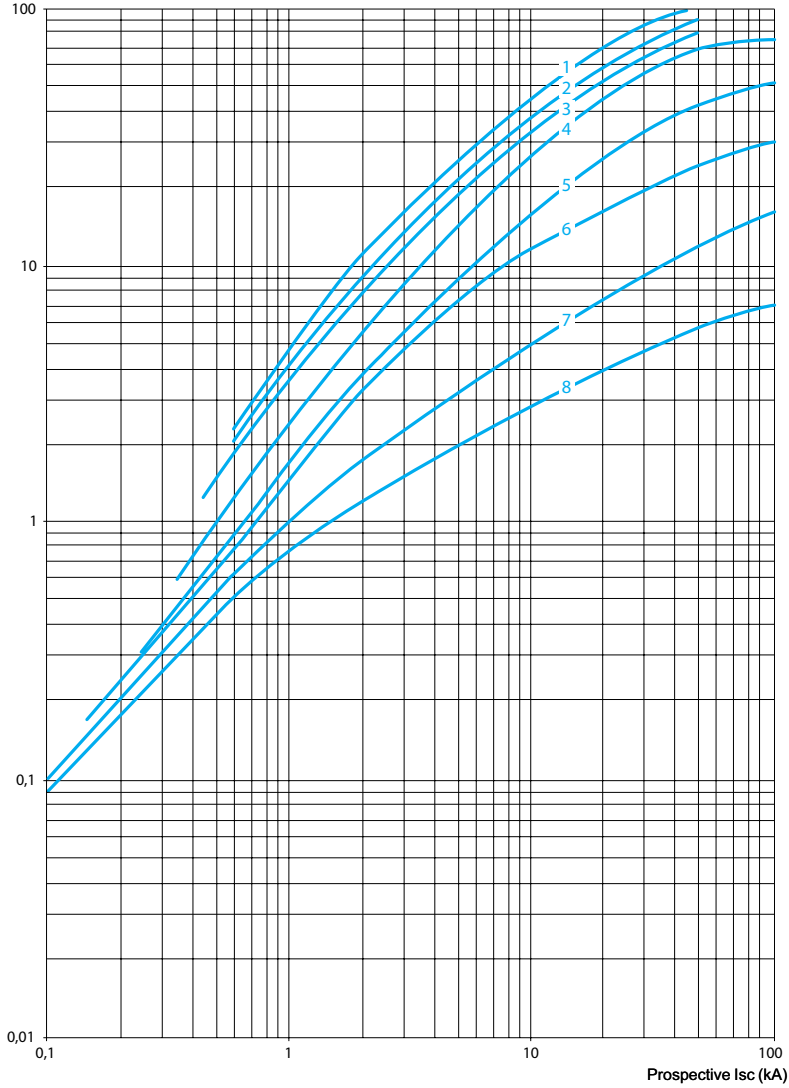

- 1 25 A and 32 A
- 2 18 A
- 3 14 A
- 4 10 A
- 5 6.3 A
- 6 4 A
- 7 2.5 A
- 8 1.6 A

Thermal limit on short-circuit for GV2 L and GV2 LE + thermal overload relay LRD or LR2 K

Thermal limit in kA²s in the magnetic operating zone

Sum of $I^2dt = f$ (prospective I_{sc}) at 1.05 $U_e = 435$ V

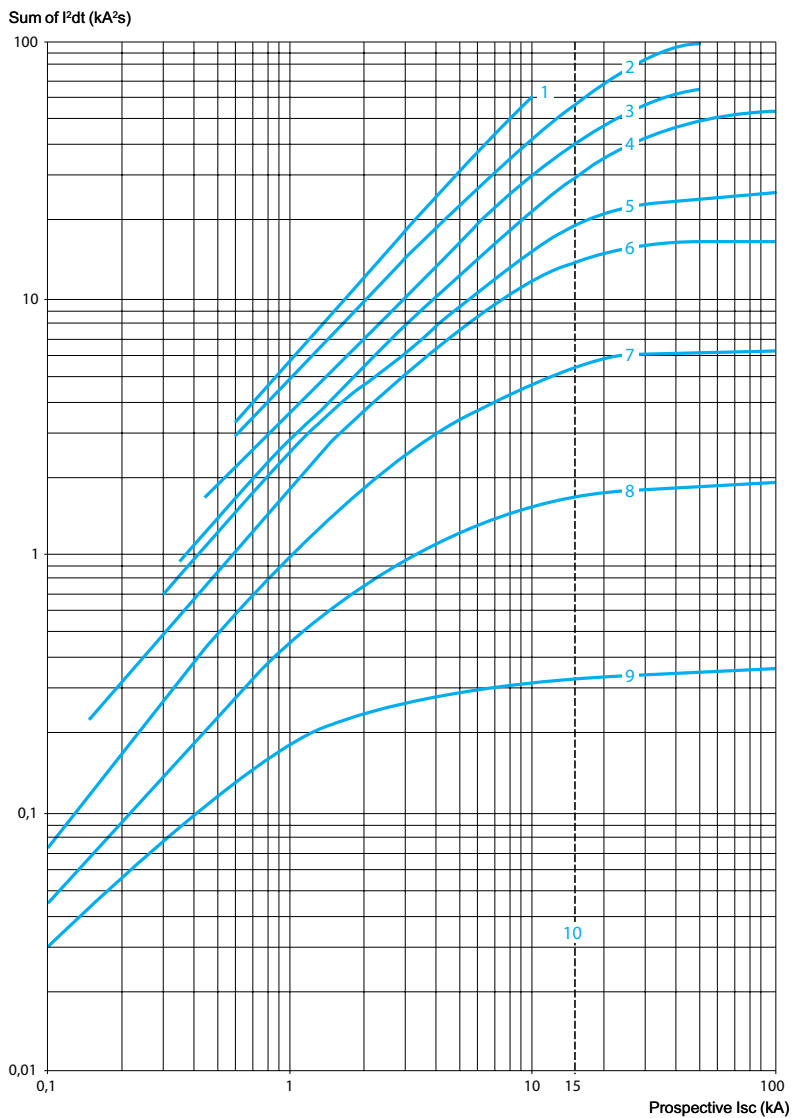

- 1 32 A (GV2 LE32)
- 2 25 A and 32 A (GV2 L32)
- 3 18 A
- 4 14 A
- 5 10 A
- 6 6.3 A
- 7 4 A
- 8 2.5 A
- 9 1.6 A
- 10 Limit of rated ultimate breaking capacity on short-circuit of GV2 LE (14, 18, 23 and 25 A ratings).

Tripping curves for GV3 L and GK3 EF80 combined with thermal overload relay LRD 33

Average operating time at 20 °C without prior current flow

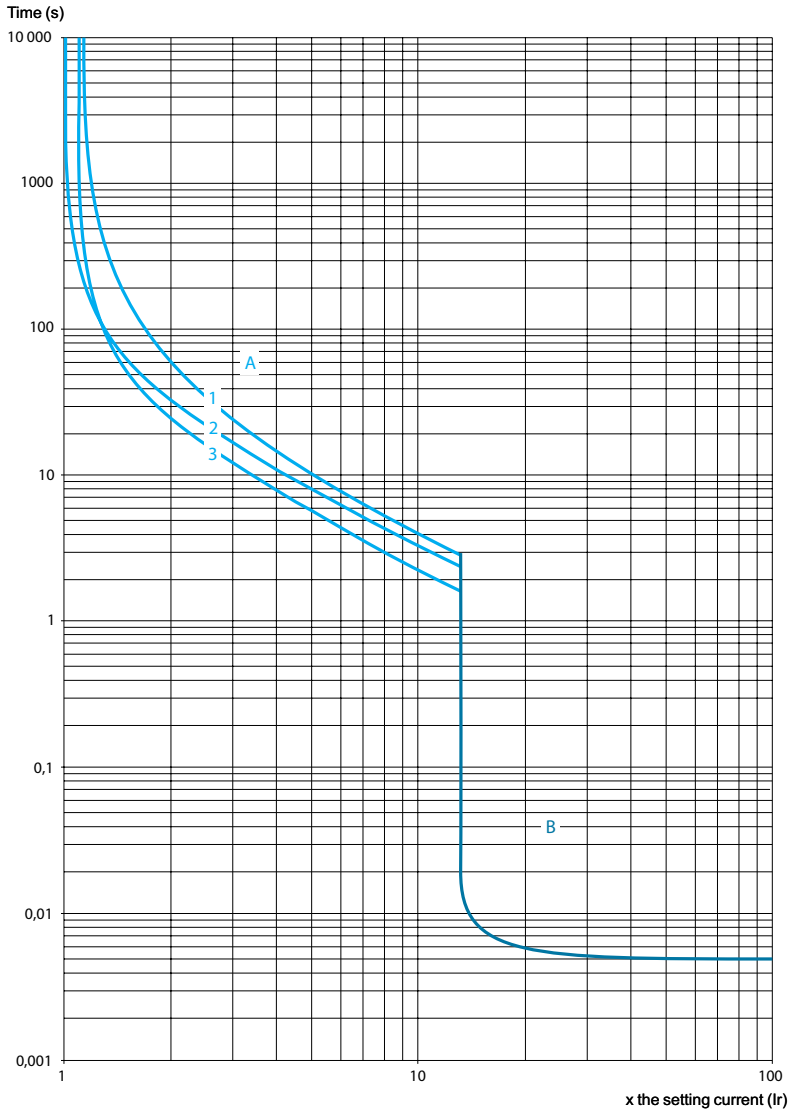

- 1 3 poles from cold state
- 2 2 poles from cold state
- 3 3 poles from hot state

- A Thermal overload relay protection zone
- B GK3 EF80 and GV3 L protection zone

Current limitation on short-circuit for GV3 L and GK3 EF80 (3-phase 400/415 V)

Dynamic stress

$I_{peak} = f(\text{prospective } I_{sc}) \text{ at } 1.05 U_e = 435 \text{ V}$

Limited peak current (kA)

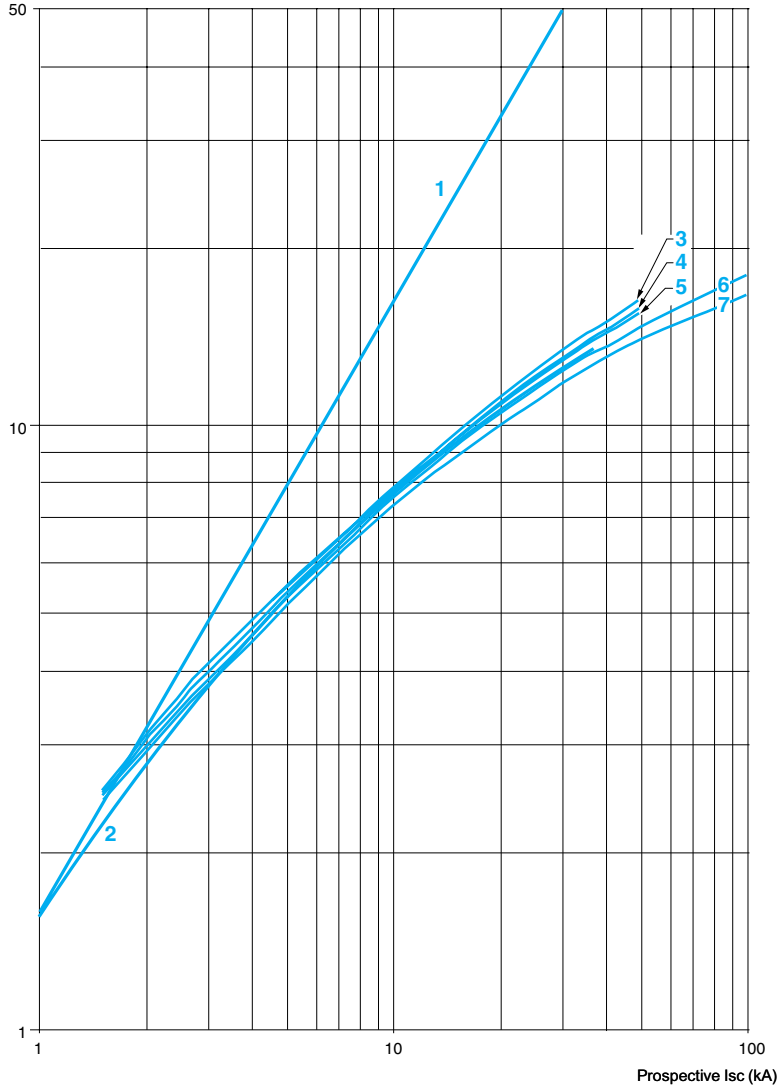

- 1 Maximum peak current
- 2 GK3 EF80
- 3 GV3 L65
- 4 GV3 L50
- 5 GV3 L40
- 6 GV3 L32
- 7 GV3 L25

Thermal limit on short-circuit for GV3 L and GK3 EF80

Thermal limit in A²s

Sum of I²dt = f (prospective I_{sc}) at 1.05 U_e = 435 V

Sum of I²dt (A²s)

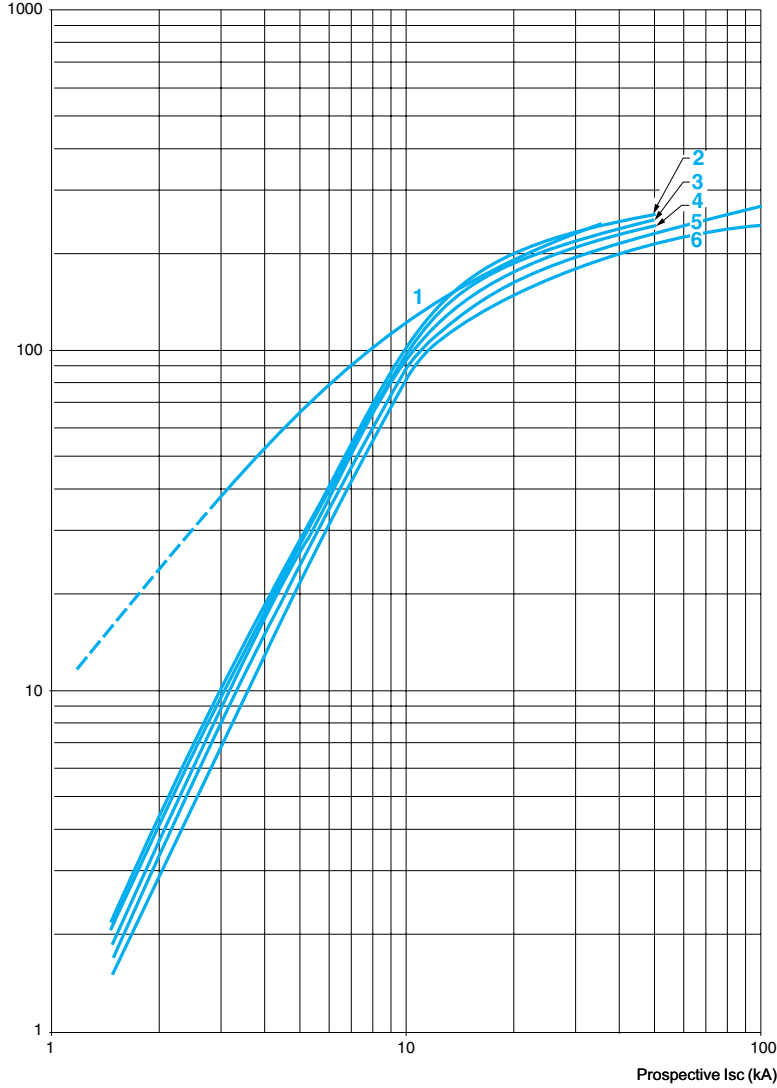

- 1 GK3 EF80
- 2 GV3 L65
- 3 GV3 L50
- 4 GV3 L40
- 5 GV3 L32
- 6 GV3 L25

3

TeSys protection components

Thermal-magnetic motor circuit-breakers

GV2 ME

528134



GV2 ME10

3

Motor circuit-breakers from 0.06 to 15 kW / 400 V, with screw clamp terminals												
GV2 ME with pushbutton control												
Standard power ratings of 3-phase motors 50/60 Hz in category AC-3									Setting range of thermal trips (2)	Magnetic tripping current I _d ± 20 %	Reference	Weight
400/415 V			500 V			690 V						
P	I _{cu}	I _{cs} (1)	P	I _{cu}	I _{cs} (1)	P	I _{cu}	I _{cs} (1)	A	A		kg
kW	kA	%	kW	kA	%	kW	kA	%				
-	-	-	-	-	-	-	-	-	0.1...0.16	1.5	GV2 ME01	0.260
0.06	*	*	-	-	-	-	-	-	0.16...0.25	2.4	GV2 ME02	0.260
0.09	*	*	-	-	-	-	-	-	0.25...0.40	5	GV2 ME03	0.260
0.12	*	*	-	-	-	0.37	*	*	0.40...0.63	8	GV2 ME04	0.260
0.18	*	*	-	-	-	-	-	-				
0.25	*	*	-	-	-	0.55	*	*	0.63...1	13	GV2 ME05	0.260
0.37	*	*	0.37	*	*	-	-	-	1...16	22.5	GV2 ME06	0.260
0.55	*	*	0.55	*	*	0.75	*	*				
-	-	-	0.75	*	*	1.1	*	*				
0.75	*	*	1.1	*	*	1.5	3	75	1.6...2.5	33.5	GV2 ME07	0.260
1.1	*	*	1.5	*	*	2.2	3	75	2.5...4	51	GV2 ME08	0.260
1.5	*	*	2.2	*	*	3	3	75				
2.2	*	*	3	50	100	4	3	75	4...6.3	78	GV2 ME10	0.260
3	*	*	4	10	100	5.5	3	75	6...10	138	GV2 ME14	0.260
4	*	*	5.5	10	100	7.5	3	75				
5.5	15	50	7.5	6	75	9	3	75	9...14	170	GV2 ME16	0.260
-	-	-	-	-	-	11	3	75				
7.5	15	50	9	6	75	15	3	75	13...18	223	GV2 ME20	0.260
9	15	40	11	4	75	18.5	3	75	17...23	327	GV2 ME21	0.260
11	15	40	15	4	75	-	-	-	20...25	327	GV2 ME22 (3)	0.260
15	10	50	18.5	4	75	22	3	75	24...32	416	GV2 ME32	0.260

Motor circuit-breakers from 0.06 to 15 kW / 400 V, with lugs

To order thermal magnetic circuit-breakers with connection by lugs, add the digit **6** to the end of reference selected above.

Example: **GV2 ME08** becomes **GV2 ME086**.

Thermal magnetic circuit-breakers GV2 ME with built-in auxiliary contact block

With instantaneous auxiliary contact block (composition, see page 3/55):

- GV AE1, add suffix **AE1TQ** to the motor circuit-breaker reference selected above.
Example: **GV2 ME01AE1TQ**.
- GV AE11, add suffix **AE11TQ** to the motor circuit-breaker reference selected above.
Example: **GV2 ME01AE11TQ**.
- GV AN11, add suffix **AN11TQ** to the motor circuit-breaker reference selected above.
Example: **GV2 ME01AN11TQ**.

These circuit-breakers with built-in contact block are sold in lots of 20 units in a single pack.

(1) As % of I_{cu}.
 (2) The thermal trip setting must be within the range marked on the graduated knob.
 (3) Maximum rating which can be mounted in enclosures **GV2 MC** or **MP**, please consult your Regional Sales Office.
 * > 100 kA.

TeSys protection components

Thermal-magnetic motor circuit-breakers

GV2 ME



GV2 ME●●3

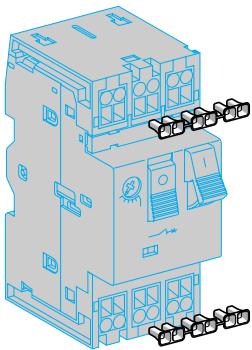

LA9 D99

Motor circuit-breakers from 0.06 to 11 kW, with spring terminal connections

GV2 ME (1) with pushbutton control							Setting range of thermal trips (3)	Magnetic tripping current Id ± 20 %	Reference	Weight
Standard power ratings of 3-phase motors 50/60 Hz in category AC-3										
400/415 V			500 V							
P	Icu	Ics (2)	P	Icu	Ics (2)	A	A		kg	
kW	kA	%	kW	kA	%					
-	-	-	-	-	-	0.1...0.16	1.5	GV2 ME013	0.280	
0.06	*	*	-	-	-	0.16...0.25	2.4	GV2 ME023	0.280	
0.09	*	*	-	-	-	0.25...0.40	5	GV2 ME033	0.280	
0.12	*	*	-	-	-	0.40...0.63	8	GV2 ME043	0.280	
0.18	*	*	-	-	-	0.63...1	13	GV2 ME053	0.280	
0.25	*	*	0.37	*	*	0.63...1	13	GV2 ME053	0.280	
0.37	*	*	0.37	*	*	1...1.6	22.5	GV2 ME063	0.280	
0.55	*	*	0.55	*	*	1...1.6	22.5	GV2 ME063	0.280	
0.75	*	*	0.75	*	*	1.6...2.5	33.5	GV2 ME073	0.280	
1.1	*	*	1.1	*	*	1.6...2.5	33.5	GV2 ME073	0.280	
1.5	*	*	1.5	*	*	2.5...4	51	GV2 ME083	0.280	
2.2	*	*	2.2	*	*	2.5...4	51	GV2 ME083	0.280	
3	*	*	3	50	100	4...6.3	78	GV2 ME103	0.280	
4	*	*	4	10	100	4...6.3	78	GV2 ME103	0.280	
5.5	15	50	5.5	10	100	6...10	138	GV2 ME143	0.280	
7.5	15	50	7.5	6	75	6...10	138	GV2 ME143	0.280	
9	15	40	9	6	75	9...14	170	GV2 ME163	0.280	
11	15	40	11	4	75	9...14	170	GV2 ME163	0.280	
11	15	40	11	4	75	13...18	223	GV2 ME203	0.280	
11	15	40	11	4	75	13...18	223	GV2 ME203	0.280	
11	15	40	11	4	75	17...23	327	GV2 ME213	0.260	
11	15	40	11	4	75	17...23	327	GV2 ME213	0.260	
11	15	40	15	4	75	20...25	327	GV2 ME223	0.260	

Contact blocks						
Description	Mounting	Maximum number	Type of contacts	Sold in lots of	Unit reference	Weight kg
Instantaneous auxiliary contacts	Front	1	N/O + N/C	10	GV AE113	0.030
			N/O + N/O	10	GV AE203	0.030
	LH side	2	N/O + N/C	1	GV AN113	0.060
			N/O + N/O	1	GV AN203	0.060

Accessory				
Description	Application	Sold in lots of	Unit reference	Weight kg
Cable end reducer	For connection of conductors from 1 to 1.5 mm ²	20	LA9 D99	-

(1) For connection of conductors from 1 to 1.5 mm², the use of an LA9 D99 cable end reducer is recommended.
 (2) Maximum rating which can be mounted in enclosures GV2 MC or MP, please consult your Regional Sales Office
 (3) The thermal trip setting must be within the range marked on the graduated knob.
 * > 100 kA.

TeSys protection components

Thermal-magnetic motor circuit-breakers GV2 P, GV3 P and GV3 ME80



GV2 P10



GV3 P65



GV3 P651

Motor circuit-breakers from 0.06 to 30 kW / 400 V

Standard power ratings of 3-phase motors 50/60 Hz in category AC-3									Setting range of thermal trips (2)	Magnetic tripping current I _d ± 20 %	Reference	Weight
400/415 V			500 V			690 V						
P	I _{cu}	I _{cs} (1)	P	I _{cu}	I _{cs} (1)	P	I _{cu}	I _{cs} (1)	A	A		kg

GV2 P: control by rotary knob

Screw clamp terminals

–	–	–	–	–	–	–	–	–	0.1...0.16	1.5	GV2 P01	0.350
0.06	★	★	–	–	–	–	–	–	0.16...0.25	2.4	GV2 P02	0.350
0.09	★	★	–	–	–	–	–	–	0.25...0.40	5	GV2 P03	0.350
0.12	★	★	–	–	–	0.37	★	★	0.40...0.63	8	GV2 P04	0.350
0.18	★	★	–	–	–	–	–	–	–	–	–	–
0.25	★	★	–	–	–	0.55	★	★	0.63...1	13	GV2 P05	0.350
0.37	★	★	0.37	★	★	–	–	–	1...1.6	22.5	GV2 P06	0.350
0.55	★	★	0.55	★	★	0.75	★	★	–	–	–	–
0.75	★	★	1.1	★	★	1.5	8	100	1.6...2.5	33.5	GV2 P07	0.350
1.1	★	★	1.5	★	★	2.2	8	100	2.5...4	51	GV2 P08	0.350
2.2	★	★	3	★	★	4	6	100	4...6.3	78	GV2 P10	0.350
3	★	★	5	50	100	5.5	6	100	6...10	138	GV2 P14	0.350
5.5	★	★	7.5	42	75	9	6	100	9...14	170	GV2 P16	0.350
–	–	–	–	–	–	11	6	100	–	–	–	–
7.5	50	50	9	10	75	15	4	100	13...18	223	GV2 P20	0.350
9	50	50	11	10	75	18.5	4	100	17...23	327	GV2 P21	0.350
11	50	50	15	10	75	–	–	–	20...25	327	GV2 P22	0.350
15	35	50	18.5	10	75	22	4	100	24...32	416	GV2 P32	0.350

GV3 P: control by rotary knob

Connection by EverLink® BTR screw connectors (3)

5.5	100	100	7.5	12	50	11	6	50	9...13	182	GV3 P13	0.960
7.5	100	100	9	12	50	15	6	50	12...18	252	GV3 P18	0.960
11	100	100	15	12	50	18.5	6	50	17...25	350	GV3 P25	0.960
15	100	100	18.5	12	50	22	6	50	23...32	448	GV3 P32	0.960
18.5	50	100	22	12	50	37	6	50	30...40	560	GV3 P40	0.960
22	50	100	30	12	50	45	6	50	37...50	700	GV3 P50	0.960
30	50	100	45	12	50	55	6	50	48...65	910	GV3 P65	0.960

Connection by EverLink® BTR screw connectors, for assembly with a contactor

To assemble a **GV3 P13** to **P65** circuit-breaker with an **LC1 D40A** to **D65A** contactor, it is possible to use the circuit-breaker supplied without downstream EverLink® power terminal block. To order this product, add the digit **1** to the end of the references selected above. Example: **GV3 P65** becomes **GV3 P651**.

Connection by lugs

To order thermal magnetic circuit-breakers with connection by lugs, add the digit **6** to the end of reference selected above. Example: **GV3 P18** becomes **GV3 P186**.

GV3 ME80: pushbutton control, screw clamp terminals

37	15	50	45	4	100	55	2	100	56...80		GV3 ME80 (4)	0.700
-----------	----	----	-----------	---	-----	-----------	---	-----	---------	--	---------------------	-------

Motor circuit-breakers up to 50 hp / 600 V, UL 508 type E

GV2 (5)

To obtain a **GV2 P** motor circuit-breaker, UL 508 type E, combine:

- a circuit-breaker **GV2 P●●H7** (except 32 A),
- and a "Large Spacing" adapter **GV2 GH7**.

GV3 (6)

To obtain a motor-circuit-breaker **GV3 P**, UL 508 type E, use the following with the circuit-breaker:

- a "Large Spacing" cover **GV3 G66**,
- a short-circuit signalling contact **GV AM11**.

GV3 with connection by lugs (6)

To obtain a motor-circuit-breaker **GV3 P**, UL 508 type E, with connection by lugs, add the digit **6** to the end of reference selected above and use the following with the circuit-breaker:

- two IP 20 covers **LAD 96570**,
- a short-circuit signalling contact **GV AM11**.

(1) As % of I_{cu}.
 (2) The thermal trip setting must be within the range marked on the graduated knob.
 (3) BTR screws: hexagon socket head. Require use of an insulated Allen key, in compliance with local wiring regulations.
 (4) Recommended for use in association with a contactor.
 (5) Accessory: see page 3/63.
 (6) Accessories: see page 3/57.
 ★ > 100 kA.

TeSys protection components

Thermal-magnetic motor circuit-breakers

GV7 R



GV7 RE40



GV7 RS220

Thermal-magnetic circuit-breakers GV7 R with screw clamp terminals

Control by rocker lever											Reference	Weight
Standard power ratings of 3-phase motors 50/60 Hz in category AC-3									Setting range of thermal trips	A		
400/415 V			500 V			660/690 V						
P	Icu	Ics (1)	P	Icu	Ics (1)	P	Icu	Ics (1)				
kW	kA	%	kW	kA	%	kW	kA	%				
7.5	36	100	9	18	100	11	8	100	12...20	GV7 RE20	2.010	
9	36	100	11	18	100	15	8	100				
7.5	70	100	9	50	100	11	10	100	12...20	GV7 RS20	2.010	
9	70	100	11	50	100	15	10	100				
9	36	100	11	18	100	15	8	100	15...25	GV7 RE25	2.010	
11	36	100	15	18	100	18.5	8	100				
9	70	100	11	50	100	15	10	100	15...25	GV7 RS25	2.010	
11	70	100	15	50	100	18.5	10	100				
18.5	36	100	18.5	18	100	22	8	100	25...40	GV7 RE40	2.010	
			22	18	100							
18.5	70	100	18.5	50	100	22	10	100	25...40	GV7 RS40	2.010	
22	36	100	30	18	100	30	8	100	30...50	GV7 RE50	2.015	
22	70	100	30	50	100	30	10	100	30...50	GV7 RS50	2.015	
37	36	100	45	18	100	55	8	100	48...80	GV7 RE80	2.040	
			55	18	100							
37	70	100	45	50	100	55	10	100	48...80	GV7 RS80	2.040	
			55	50	100							
45	36	100	–	18	100	75	8	100	60...100	GV7 RE100	2.040	
45	70	100	–	50	100	75	10	100	60...100	GV7 RS100	2.040	
55	35	100	75	30	100	90	8	100	90...150	GV7 RE150	2.020	
75	35	100	90	30	100	110	8	100				
55	70	100	75	50	100	90	10	100	90...150	GV7 RS150	2.020	
75	70	100	90	50	100	110	10	100				
90	35	100	110	30	100	160	8	100	132...220	GV7 RE220	2.350	
110	35	100	132	30	100	200	8	100				
			160	30	100							
90	70	100	110	50	100	160	10	100	132...220	GV7 RS220	2.350	
110	70	100	132	50	100	200	10	100				
			160	50	100							

(1) As % of Icu

TeSys protection components

Thermal-magnetic circuit-breakers

GV2 RT



GV2 RT

For motors with high current peak on starting								
Control by rocker lever								
Standard power ratings of 3-phase motors 50/60 Hz in category AC-3					Setting range of thermal trips (1)	Magnetic tripping current I _d ± 20 %	Reference	Weight
220/ 230 V	400/ 415 V	440 V	500 V	690 V				
kW	kW	kW	kW	kW	A	A		kg
0.06	0.09	0.09 0.12	–	–	0.25...0.40	8	GV2 RT03	0.350
–	0.12 0.18	0.18	–	0.37	0.40...0.63	13	GV2 RT04	0.350
0.09 0.12	0.25 0.37	0.25 0.37	0.37	0.55	0.63...1	22	GV2 RT05	0.350
0.18 0.25	0.37 0.55	0.37 0.55	0.37 0.55 0.75	0.75 1.1	1...1.6	33	GV2 RT06	0.350
0.37	0.75	0.75 1.1	1.1	1.5	1.6...2.5	51	GV2 RT07	0.350
0.55 0.75	1.1 1.5	1.5	1.5 2.2	2.2 3	2.5...4	78	GV2 RT08	0.350
1.1	2.2	2.2 3	3	4	4...6.3	138	GV2 RT10	0.350
1.5 2.2	3 4	4	4 5.5	5.5 7.5	6...10	200	GV2 RT14	0.350
2.2 3	5.5	5.5 7.5	7.5	9 11	9...14	280	GV2 RT16	0.350
4	7.5	7.5 9	9	15	13...18	400	GV2 RT20	0.350
5.5	9 11	11	11	18.5	17...23	400	GV2 RT21	0.350

(1) The thermal trip setting must be within the range marked on the graduated knob.



GV2 RT

For primaries of 3-phase transformers										
Control by rocker lever										
Standard power ratings					Setting range of thermal trips (1)	Magnetic tripping current $I_d \pm 20\%$	Reference	Weight		
230/240 V	400/415 V	440 V	500 V	690 V					A	A
–	–	–	–	–	0.25...0.40	8	GV2 RT03	0.350		
–	–	–	–	–	0.40...0.63	13	GV2 RT04	0.350		
–	–	0.63	0.63	1	0.63...1	22	GV2 RT05	0.350		
0.4	0.63	1	1	–	1...1.6	33	GV2 RT06	0.350		
0.63	1	–	1.6	1.6 2	1.6...2.5	51	GV2 RT07	0.350		
1	1.6 2	1.6 2	2 2.5	2.5	2.5...4	78	GV2 RT08	0.350		
1.6 2	2.5	2.5 4	4	4 5 6.3	4...6.3	138	GV2 RT10	0.350		
2.5	4 5	5	5 6.3	–	6...10	200	GV2 RT14	0.350		
4	6.3	6.3	–	10 12.5	9...14	280	GV2 RT16	0.350		
5 6.3	10	10	10 12.5	10	13...18	400	GV2 RT20	0.350		

Accessory (2)			
Description	Reference	Weight	kg
Padlockable external operator (IP 54) black handle, blue legend plate	GV2 AP03	0.280	

(1) The thermal trip setting must be within the range marked on the graduated knob.

(2) Other accessories such as mounting, cabling and marking accessories are identical to those used for GV2 ME motor circuit-breakers, see page 3/57.

TeSys protection components

Magnetic motor circuit-breakers

GV2 LE

528144



GV2 LE10

Magnetic motor circuit-breakers from 0.06 to 15 kW

GV2 L: control by rocker lever, connection by screw clamp terminals

Standard power ratings of 3-phase motors

50/60 Hz in category AC-3

Magnetic
protection
ratingTripping
current
I_d ± 20 %Use in
association
with
thermal
overload
relay

Reference

Weight

400/415 V 500 V 690 V

P I_{cu} I_{cs} (1) P I_{cu} I_{cs} (1) P I_{cu} I_{cs} (1)

kW	kA		kW	kA		kW	kA		A	A		kg	
0.06	★	★	-	-	-	-	-	-	0.4	5	LR2 K0302	GV2 LE03	0.330
0.09	★	★	-	-	-	-	-	-	0.4	5	LR2 K0304	GV2 LE03	0.330
0.12	★	★	-	-	-	0.37	★	★	0.63	8	LR2 K0304	GV2 LE04	0.330
0.18	★	★	-	-	-	-	-	-	0.63	8	LR2 K0305	GV2 LE04	0.330
-	-	-	-	-	-	0.55	★	★	1	13	LR2 K0305	GV2 LE05	0.330
0.25	★	★	-	-	-	-	-	-	1	13	LR2 K0306	GV2 LE05	0.330
-	-	-	-	-	-	0.75	★	★	1	13	LR2 K0306	GV2 LE05	0.330
0.37	★	★	0.37	★	★	-	-	-	1	13	LR2 K0306	GV2 LE05	0.330
0.55	★	★	0.55	★	★	1.1	★	★	1.6	22.5	LR2 K0307	GV2 LE06	0.330
-	-	-	0.75	★	★	-	-	-	1.6	22.5	LR2 K0307	GV2 LE06	0.330
0.75	★	★	1.1	★	★	1.5	3	75	2.5	33.5	LR2 K0308	GV2 LE07	0.330
1.1	★	★	-	-	-	-	-	-	2.5	33.5	LR2 K0308	GV2 LE07	0.330
1.5	★	★	1.5	★	★	3	3	75	4	51	LR2 K0310	GV2 LE08	0.330
-	-	-	2.2	★	★	-	-	-	4	51	LR2 K0312	GV2 LE08	0.330
2.2	★	★	3	50	100	4	3	75	6.3	78	LR2 K0312	GV2 LE10	0.330
3	★	★	4	10	100	5.5	3	75	10	138	LR2 K0314	GV2 LE14	0.330
4	★	★	5.5	10	100	-	-	-	10	138	LR2 K0316	GV2 LE14	0.330
-	-	-	-	-	-	7.5	3	75	10	138	LRD 14	GV2 LE14	0.330
-	-	-	-	-	-	9	3	75	14	170	LRD 16	GV2 LE16	0.330
5.5	15	50	7.5	6	75	11	3	75	14	170	LR2 K0321	GV2 LE16	0.330
7.5	15	50	9	6	75	15	3	75	18	223	LRD 21	GV2 LE20	0.330
9	15	40	11	4	75	18.5	3	75	25	327	LRD 22	GV2 LE22	0.330
11	15	40	15	4	75	-	-	-	25	327	LRD 22	GV2 LE22	0.330
15	10	50	18.5	4	75	22	3	75	32	416	LRD 32	GV2 LE32	0.330

(1) As % of I_{cu}.

★ > 100 kA.

TeSys protection components

Magnetic motor circuit-breakers GV2 L, GV3 L and GK3 EF80



GV2 L10



GV3 L65



GK3 EF80

Motor circuit-breakers from 0.09 to 30 kW

GV2 L: Control by rotary knob, connection by screw clamp terminals

Standard power ratings of 3-phase motors 50/60 Hz in category AC-3									Magnetic protection rating	Tripping current I _d ± 20 %	Use in association with thermal overload relay (class 10 A)	Reference	Weight
400/415 V			500 V			690 V							
P	I _{cu}	I _{cs} (1)	P	I _{cu}	I _{cs} (1)	P	I _{cu}	I _{cs} (1)					
kW	kA		kW	kA		kW	kA		A	A			kg
0.09	*	*	-	-	-	-	-	-	0.4	5	LRD 03	GV2 L03	0.330
0.12	*	*	-	-	-	0.37	*	*	0.63	8	LRD 04	GV2 L04	0.330
0.18	*	*	-	-	-	-	-	-	0.63	8	LRD 04	GV2 L04	0.330
-	-	-	-	-	-	0.55	*	*	1	13	LRD 05	GV2 L05	0.330
0.25	*	*	-	-	-	-	-	-	1	13	LRD 05	GV2 L05	0.330
-	-	-	-	-	-	0.75	*	*	1	13	LRD 06	GV2 L05	0.330
0.37	*	*	0.37	*	*	-	-	-	1	13	LRD 05	GV2 L05	0.330
0.55	*	*	0.55	*	*	1.1	*	*	1.6	22.5	LRD 06	GV2 L06	0.330
-	-	-	0.75	*	*	-	-	-	1.6	22.5	LRD 06	GV2 L06	0.330
0.75	*	*	1.1	*	*	1.5	4	100	2.5	33.5	LRD 07	GV2 L07	0.330
1.1	-	-	-	-	-	-	-	-	-	-	LRD 08	GV2 L08	0.330
1.5	*	*	1.5	*	*	3	4	100	4	51	LRD 08	GV2 L08	0.330
-	-	-	-	-	-	-	-	-	-	-	LRD 08	GV2 L08	0.330
2.2	*	*	3	*	*	4	4	100	6.3	78	LRD 10	GV2 L10	0.330
3	*	*	4	10	100	5.5	4	100	10	138	LRD 12	GV2 L14	0.330
4	-	-	-	-	-	-	-	-	-	-	LRD 14	GV2 L14	0.330
-	-	-	-	-	-	7.5	4	100	10	138	LRD 14	GV2 L14	0.330
-	-	-	-	-	-	9	4	100	14	170	LRD 16	GV2 L16	0.330
5.5	50	50	7.5	10	75	11	4	100	14	170	LRD 16	GV2 L16	0.330
7.5	50	50	9	10	75	15	4	100	18	223	LRD 21	GV2 L20	0.330
9	50	50	11	10	75	18.5	4	100	25	327	LRD 22	GV2 L22	0.330
11	50	50	15	10	75	-	-	-	25	327	LRD 22	GV2 L22	0.330
15	35	50	18.5	10	75	22	4	100	32	416	LRD 32	GV2 L32	0.330

GV3 L: control by rotary knob, connection by EverLink® BTR screw connectors

Standard power ratings of 3-phase motors 50/60 Hz in category AC-3									Magnetic protection rating	Tripping current I _d ± 20 %	Use in association with thermal overload relay (class 10 A)	Reference	Weight
400/415 V			500 V			690 V							
P	I _{cu}	I _{cs} (1)	P	I _{cu}	I _{cs} (1)	P	I _{cu}	I _{cs} (1)					
kW	kA		kW	kA		kW	kA		A	A			kg
11	100	100	15	12	50	18.5	6	50	25	350	LRD 325	GV3 L25	0.960
15	100	100	18.5	12	50	22	6	50	32	448	LRD 332	GV3 L32	0.960
18.5	50	100	22	12	50	37	6	50	40	560	LRD 340	GV3 L40	0.960
22	50	100	30	12	50	45	6	50	50	700	LRD 350	GV3 L50	0.960
30	50	100	37	12	50	55	6	50	65	910	LRD 365	GV3 L65	0.960

Connection by EverLink® BTR screw connectors, for assembly with a contactor

To assemble a **GV3 L25** to **L65** circuit-breaker with an **LC1 D40A** to **D65A** contactor, it is possible to use the circuit-breaker supplied without downstream EverLink® power terminal block. To order this product, add the digit **1** to the end of the references selected above. Example: **GV3 L65** becomes **GV3 L651**.

Connection by lugs

To order these circuit-breakers with connection by lugs, add the digit **6** to the end of reference selected above. Example: **GV3 L32** becomes **GV3 L326**.

GK3: control by rotary knob, connection by screw clamp terminals

37	35	25	55	15	30	-	-	-	80	1040	LRD 3363	GK3 EF80	0.795
----	----	----	----	----	----	---	---	---	----	------	----------	----------	-------

(1) As % of I_{cu}. Associated current limiter or fuses, where required. See characteristics page 3/17.

* > 100 kA.

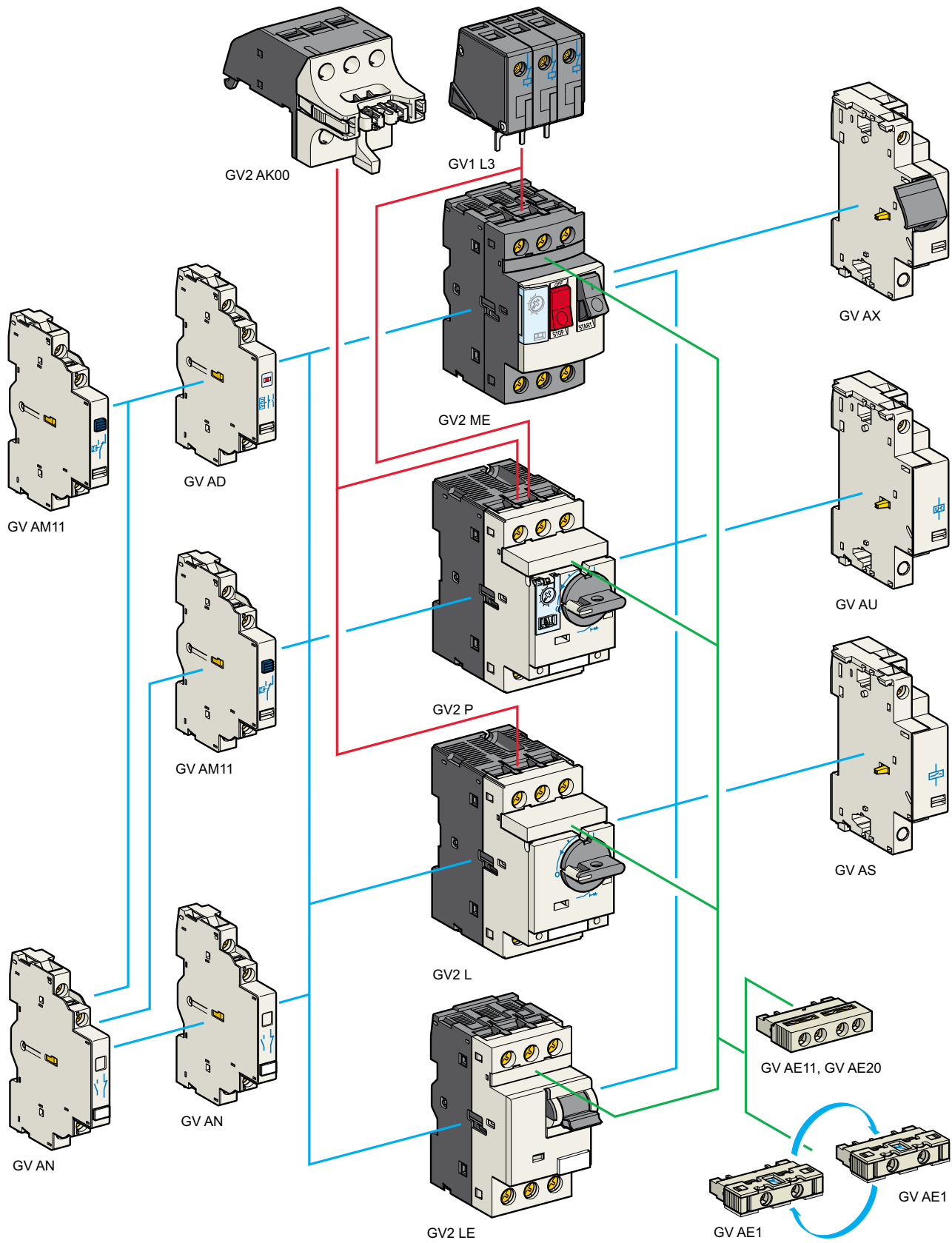

TeSys protection components

Thermal-magnetic and magnetic motor circuit-breakers GV2 with screw clamp connections

Add-on blocks and accessories

Contact blocks							
Description	Mounting	Maximum number	Type of contacts	Sold in lots of	Unit reference	Weight kg	
Instantaneous auxiliary contacts	Front (1)	1	N/O or N/C (2)	10	GV AE1	0.015	
			N/O + N/C	10	GV AE11	0.020	
			N/O + N/O	10	GV AE20	0.020	
	Side (LH)	2	N/O + N/C	1	GV AN11	0.050	
			N/O + N/O	1	GV AN20	0.050	
Fault signalling contact + instantaneous auxiliary contact	Side (3) (LH)	1	N/O (fault)	+ N/O	1	GV AD1010	0.055
				+ N/C	1	GV AD1001	0.055
			N/C (fault)	+ N/O	1	GV AD0110	0.055
				+ N/C	1	GV AD0101	0.055
Short-circuit signalling contact	Side (LH)	1	C/O common point	1	GV AM11	0.045	

Electric trips				
Mounting	Voltage		Reference	Weight kg
Undervoltage or shunt trips (4)				
Side (1 block on RH side of circuit-breaker)	24 V	50 Hz	GV A●025	0.105
		60 Hz	GV A●026	0.105
	48 V	50 Hz	GV A●055	0.105
		60 Hz	GV A●056	0.105
	100 V	50 Hz	GV A●107	0.105
	100...110 V	60 Hz	GV A●107	0.105
	110...115 V	50 Hz	GV A●115	0.105
		60 Hz	GV A●116	0.105
	120...127 V	50 Hz	GV A●125	0.105
	127 V	60 Hz	GV A●115	0.105
	200 V	50 Hz	GV A●207	0.105
	200...220 V	60 Hz	GV A●207	0.105
	220...240 V	50 Hz	GV A●225	0.105
		60 Hz	GV A●226	0.105
	380...400 V	50 Hz	GV A●385	0.105
		60 Hz	GV A●386	0.105
	415...440 V	50 Hz	GV A●415	0.105
	415 V	60 Hz	GV A●416	0.105
	440 V	60 Hz	GV A●385	0.105
	480 V	60 Hz	GV A●415	0.105
500 V	50 Hz	GV A●505	0.105	
600 V	60 Hz	GV A●505	0.105	

Undervoltage trip, INRS (can only be mounted on GV2 ME)				
Safety device for dangerous machines conforming to INRS and VDE 0113				
Side (1 block on RH side of circuit-breaker GV2 ME)	110...115 V	50 Hz	GV AX115	0.110
		60 Hz	GV AX116	0.110
	127 V	60 Hz	GV AX115	0.110
		60 Hz	GV AX225	0.110
	220...240 V	50 Hz	GV AX225	0.110
		60 Hz	GV AX226	0.110
	380...400 V	50 Hz	GV AX385	0.110
		60 Hz	GV AX386	0.110
415...440 V	50 Hz	GV AX415	0.110	
440 V	60 Hz	GV AX385	0.110	

Add-on contact blocks				
Description	Mounting	Maximum number	Reference	Weight kg
Visible isolation block (5)	Front (1)	1	GV2 AK00	0.150
Limiters	At top (GV2 ME and GV2 P)	1	GV1 L3	0.130
	Independent	1	LA9 LB920	0.320

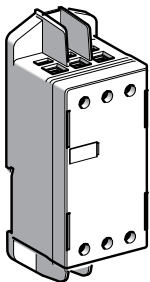

LA9 LB920

- (1) Mounting of a GV AE contact block or a GV2 AK00 visible isolation block on GV2 P and GV2 L.
 (2) Choice of N/C or N/O contact operation, depending on which way round the reversible block is mounted.
 (3) The GV AD is always mounted next to the circuit-breaker.
 (4) To order an undervoltage trip: replace the dot (●) in the reference with a U, example: GV AU025.
 To order a shunt trip: replace the dot (●) in the reference with an S, example: GV AS025.
 (5) Visible isolation of the 3 poles upstream of circuit-breaker GV2 P and GV2 L.
 Visible isolation block GV2 AK00 cannot be used with motor circuit-breakers GV2 P32 and GV2 L32 (Ith max = 25 A).

3

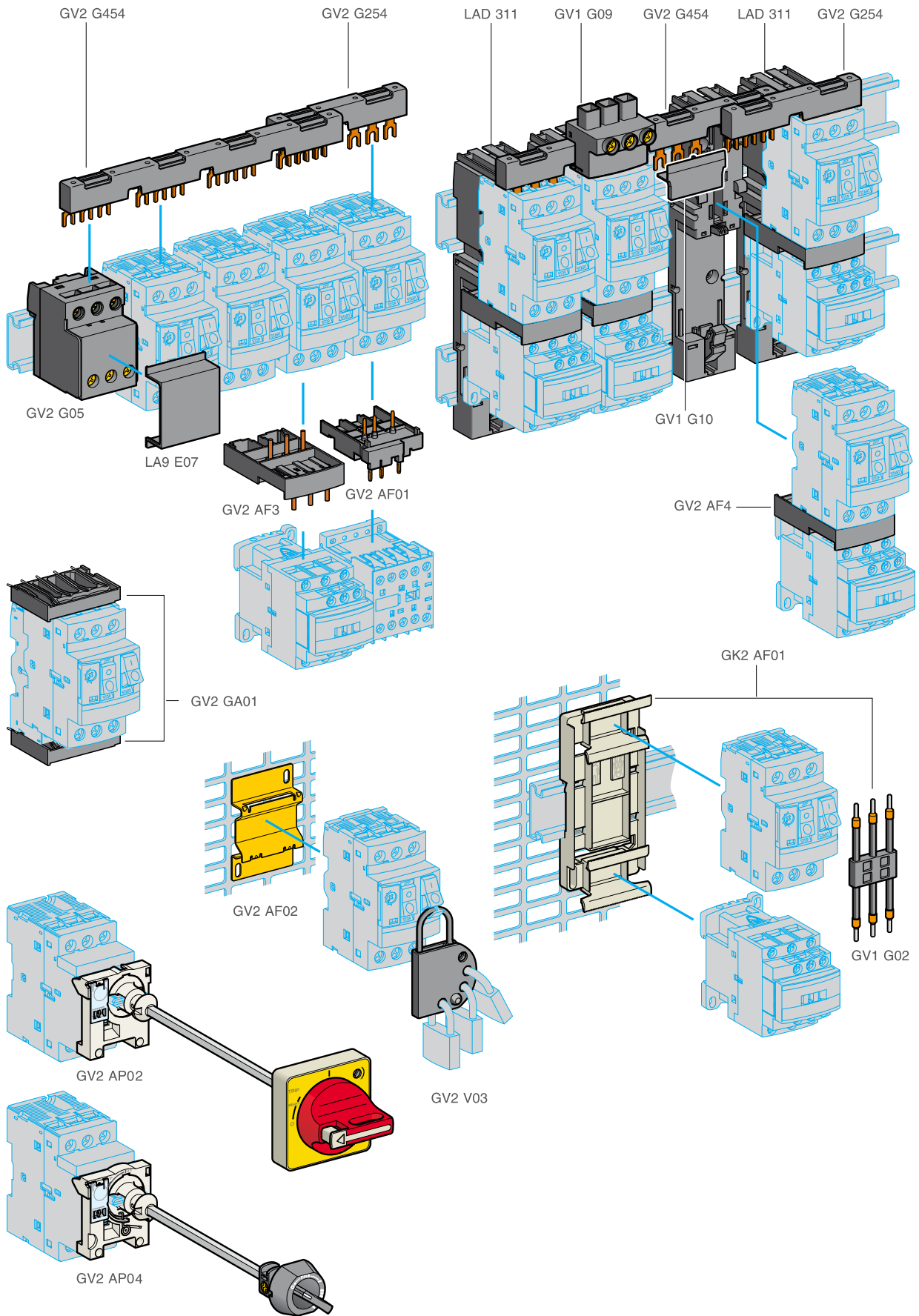

TeSys protection components

Thermal-magnetic and magnetic motor circuit-breakers GV2 with screw clamp connections

Accessories

Accessories				
Description	Application	Sold in lots of	Unit reference	Weight kg
Adapter plates	For mounting a GV2 ME or GV2 LE by screw fixing	10	GV2 AF02	0.021
	For mounting a GV2 ME or GV2 P and contactor LC1 D09...D38 with front faces aligned	1	LAD 311	0.040
Height compensation plate	7,5 mm	10	GV1 F03	0.003
Combination blocks	Between GV2 and contactor LC1 K or LP1 K	10	GV2 AF01	0.020
	Between GV2 and contactor LC1 D09...D38	10	GV2 AF3	0.016
	Between GV2 mounted on LAD 311 and contactor LC1 D09...D38	10	GV2 AF4	0.016
Motor starter adapter plate	With 3-pole connection for mounting a GV2 and a contactor LC1 D09...D25	1	GK2 AF01	0.120
Description	Application	Pitch mm	Reference	Weight kg
Sets of 3-pole 63 A busbars	2 tap-offs	45	GV2 G245	0.036
		54	GV2 G254	0.038
		72	GV2 G272	0.042
	3 tap-offs	45	GV2 G345	0.058
		54	GV2 G354	0.060
		72	GV2 G454	0.085
	4 tap-offs	45	GV2 G445	0.077
		54	GV2 G454	0.085
		72	GV2 G472	0.094
	5 tap-offs	54	GV2 G554	0.100
Description	Application	Sold in lots of	Unit reference	Weight kg
Protective end cover	For unused busbar outlets	5	GV1 G10	0.005
Terminal block for supply to one or more GV2 G busbar sets	Connection from the top	1	GV1 G09	0.040
	Can be fitted with current limiter GV1 L3 (GV2 ME and GV2 P)	1	GV2 G05	0.115
Cover for terminal block	For mounting in modular panels	10	LA9 E07	0.005
Flexible 3-pole connection for connecting a GV2 to a contactor LC1-D09...D25	Centre distance between mounting rails: 100...120 mm	10	GV1 G02	0.013
Set of connections upstream/downstream	For connecting GV2 ME to a printed circuit board	10	GV2 GA01	0.045
"Large Spacing" adapter UL 508 type E	For GV2 P●●H7 (except 32 A)	1	GV2 GH7	0.040
Clip-in marker holders (supplied with each circuit-breaker)	For GV2 P, GV2 L, GV2 LE and GV2 RT (8 x 22 mm)	100	LA9 D92	0.001
External operators				
Description			Reference	Weight kg
For GV2 P and GV2 L (150 to 290 mm)	Padlocking in "On" and "Off" position Black handle, blue front plate, IP 54		GV2 AP01	0.200
	Padlocking in "Off" position Red handle, yellow front plate, IP 54		GV2 AP02	0.200
	Cannot be padlocked in "On" and "Off" positions Does not lock the door or drawer operator in the "On" position. Colour: RAL 7016, IP 42		GV2 AP04	0.104
For GV2 LE	Padlocking in "On" and "Off" position Black handle, blue front plate, IP 54		GV2 AP03	0.280
Padlocking device				
Description			Reference	Weight kg
For all GV2 device	For use with up to 4 padlocks, Ø 6 mm shank max. (padlocks not included)		GV2 V03	0.092

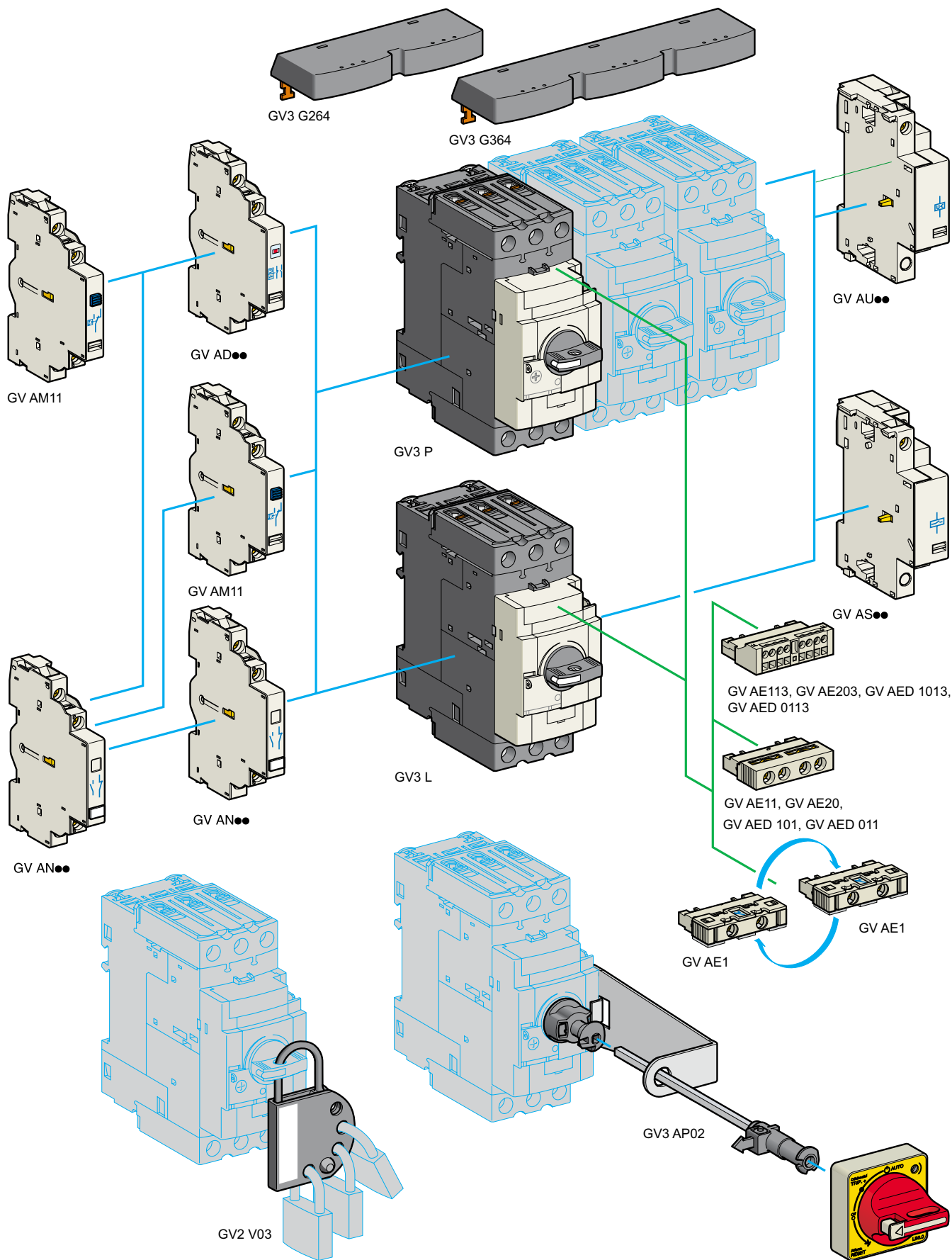

TeSys protection components

Thermal-magnetic motor circuit-breakers

GV3 P and GV3 L

Add-on blocks and accessories

Contact blocks							
Description	Mounting	Maximum number	Type of contacts	Sold in lots of	Unit reference	Weight kg	
Instantaneous auxiliary contacts	Front	1	N/O or N/C (1)	10	GV AE1	0.015	
			N/O + N/C	10	GV AE11 (2)	0.020	
			N/O + N/O	10	GV AE20 (2)	0.020	
	Side (LH)	2	N/O + N/C	1	GV AN11 (2)	0.050	
			N/O + N/O	1	GV AN20 (2)	0.050	
Fault signalling contact + instantaneous auxiliary contact	Front	1	N/O (fault)	+ N/O	1	GV AED101 (2)	0.020
			N/O (fault)	+ N/C	1	GV AED011 (2)	0.020
	Side (3) (LH)	1	N/O (fault)	+ N/O	1	GV AD1010	0.055
				+ N/C	1	GV AD1001	0.055
				N/C (fault)	+ N/O	1	GV AD0110
				+ N/C	1	GV AD0101	0.055
	Short-circuit signalling contact	Side (LH)	1	C/O common point	1	GV AM11	0.045

Electric trips - undervoltage or shunt (4)				
Mounting	Voltage		Reference	Weight kg
Side (1 block on RH side of circuit-breaker)	24 V	50 Hz	GV A●025	0.105
		60 Hz	GV A●026	0.105
	48 V	50 Hz	GV A●055	0.105
		60 Hz	GV A●056	0.105
	100	50 Hz	GV A●107	0.105
	100...110 V	60 Hz	GV A●107	0.105
	110...115 V	50 Hz	GV A●115	0.105
		60 Hz	GV A●116	0.105
	120...127 V	50 Hz	GV A●125	0.105
	127 V	60 Hz	GV A●115	0.105
	200 V	50 Hz	GV A●207	0.105
	200...220 V	60 Hz	GV A●207	0.105
	220...240 V	50 Hz	GV A●225	0.105
		60 Hz	GV A●226	0.105
	380...400 V	50 Hz	GV A●385	0.105
		60 Hz	GV A●386	0.105
	415...440 V	50 Hz	GV A●415	0.105
	415 V	60 Hz	GV A●416	0.105
	440 V	60 Hz	GV A●385	0.105
	480 V	60 Hz	GV A●415	0.105
500 V	50 Hz	GV A●505	0.105	
600 V	60 Hz	GV A●505	0.105	

Padlockable external operators for GV3 P and GV3 L			
Description		Reference	Weight kg
External operators comprising: an LU9 AP1● handle, a shaft (max. length: 260 mm), a bracket and an adaptor.	Padlocking in "On" and "Off" position Black handle, blue front plate, IP 54	GV3 AP01	0.294
	Padlocking in "Off" position Red handle, yellow front plate, IP 54	GV3 AP02	0.294
Handles only	Black handle, blue front plate, IP 54	LU9 AP11	0.105
	Red handle, yellow front plate, IP 54	LU9 AP12	0.105

Accessories				
Description	For circuit-breakers	Reference	Weight kg	
Sets of 3-pole 115 A busbars Pitch: 64 mm	2 tap-off	GV3 P●● and GV3 L●●	GV3 G264	0.150
	3 tap-off	GV3 P●● and GV3 L●●	GV3 G364	0.250
Cover "Large Spacing" UL 508 type E (Only one cover required on supply side)		GV3 P●●	GV3 G66	0.020
IP 20 cover (Two covers required per breaker)		GV3 P●●6 and GV3 L●●6	LAD 96570	0.021
IP 20 cover for use when mounted with circuit-breakers		GV3 P●●6 and GV3 L●●6	LAD 96575	0.010
Size 4 Allen key, insulated, 1000 V		GV3 P●● and GV3 L●●	LAD ALLEN4 (5)	0.026
Padlocking device for use with up to 4 padlocks (not supplied) Ø 6 mm shank max.		GV3 P●● and GV3 L●● GV3 P●●6 and GV3 L●●6	GV2 V03	0.092
Retrofit plate for screw fixing	Replacement of GV3 ME with GV3 P●● or GV2 P●●		LAD 7X3	0.150

- (1) Choice of N/C or N/O contact operation, depending on which way round the reversible block is mounted.
(2) Contact blocks available in version with spring terminal connections. Add a figure 3 at the end of the references selected above.
Example: GV AED101 becomes GV AED1013.
(3) The GV AD●● is always mounted next to the circuit-breaker.
(4) To order an undervoltage trip: replace the dot (●) in the reference with a U, example: GV AU025.
To order a shunt trip: replace the dot (●) in the reference with an S, example: GV AS025.
(5) Sold in lots of 5.

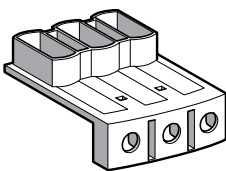

GV3 G66

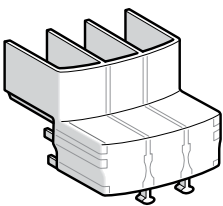

LAD 96570

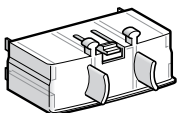

LAD 96575

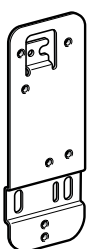

LAD 7X3

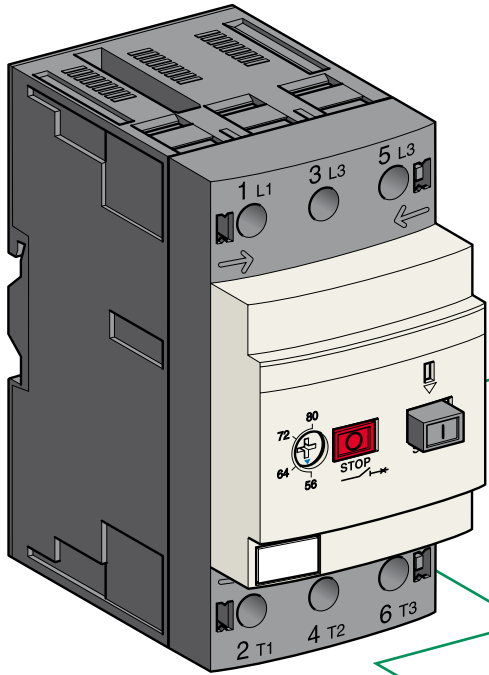

GV3 ME80

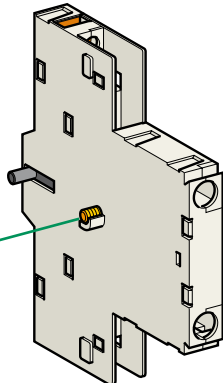

GV3 A01...A07

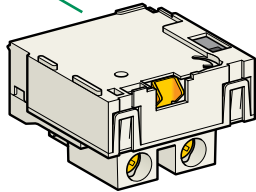

GV3 B●●
GV3 D●●

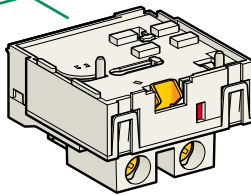

GV3 A08
GV3 A09

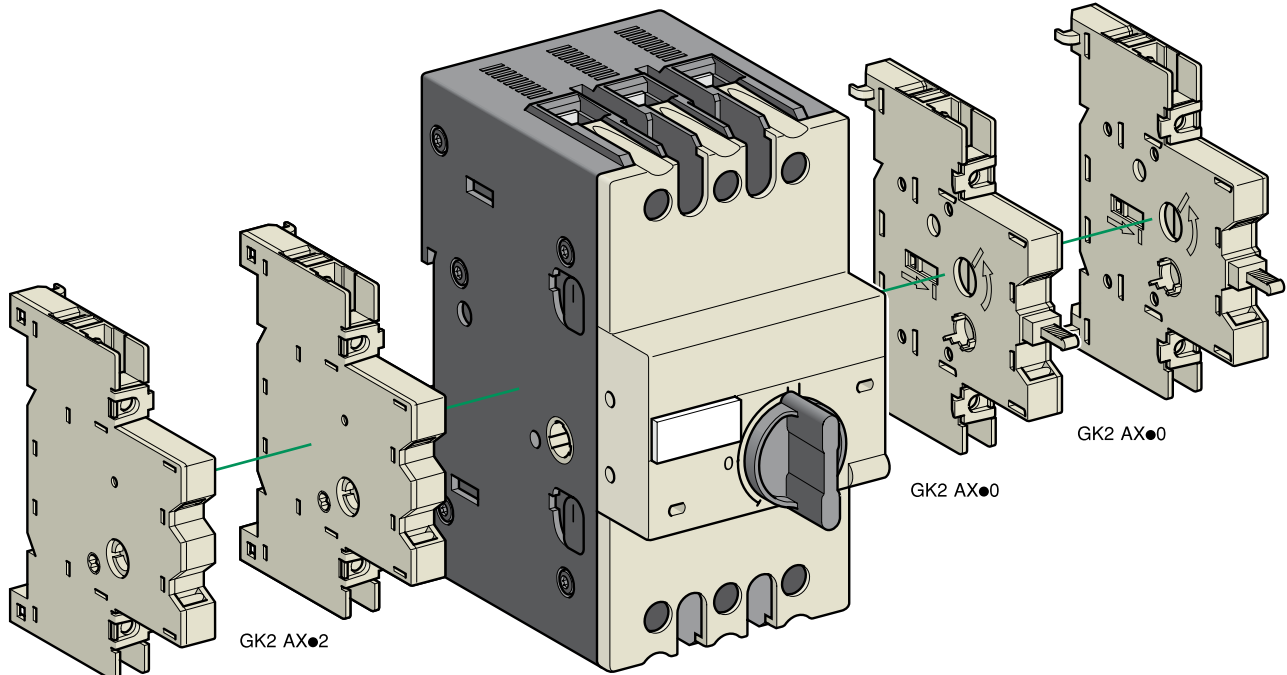

GK2 AX●2

GK2 AX●2

GK3 EF80

GK2 AX●0

GK2 AX●0

TeSys protection components

Motor circuit-breakers GV3 ME80 and GK3 EF80

Add-on blocks and accessories

For thermal-magnetic motor circuit-breakers GV3 ME80

Contact blocks

Description	Type of standard early break contacts	Reference	Weight kg
Instantaneous auxiliary contact blocks (1 per circuit-breaker)	N/C + N/O	GV3 A01	0,060
	N/O + N/O	GV3 A02	0.060
	N/C + N/O + N/O	GV3 A03	0.070
	N/O + N/O + N/O	GV3 A05	0.070
	N/O + N/O + 2 volt-free terminals	GV3 A06	0.070
	N/C + N/O + 2 volt-free terminals	GV3 A07	0.070
Fault signalling contacts (1)	N/C	GV3 A08	0.030
	N/O	GV3 A09	0.030

Electric trips

Description	Voltages		Reference	Weight kg
	50 Hz	60 Hz		
Undervoltage trips (1)	110, 120, 127 V	120, 127 V	GV3 B11	0.070
	220, 240 V	277 V	GV3 B22	0.070
	380, 415 V	440 V, 480 V	GV3 B38	0.070
Shunt trips (1)	110, 120, 127 V	120, 127 V	GV3 D11	0.070
	220, 240 V	277 V	GV3 D22	0.070
	380, 415 V	440 V, 480 V	GV3 D38	0.070

Accessory

Description	Sold in lots of	Unit reference	Weight kg
Padlocking device, for locking the Start button (on open-mounted product)	5	GV1 V02	0.010

For magnetic circuit-breaker GK3 EF80

Contact blocks

Description	Number of poles	Reference	Weight kg
Auxiliary contact blocks for On-Off signalling and "control circuit test" function (1 or 2 blocks per device) mounted on RH side of GK3 EF80	N/O	GK2 AX10	0.025
	N/O + N/O	GK2 AX20	0.031
	N/C + N/O	GK2 AX50	0.031
Instantaneous fault signalling contact blocks (1 or 2 blocks per device) mounted on LH side of GK3 EF80	N/O	GK2 AX12	0.025
	N/O + N/O	GK2 AX22	0.031
	N/C + N/O	GK2 AX52	0.031

Accessories

Description	Reference	Weight kg
Padlocking device for padlocking the operator, using up to 3 padlocks (padlocks to be ordered separately)	GK3 AV01	0.020
External operator for mounting on enclosure door. Red Ø 40 knob on yellow plate, padlockable in position O (with up to 3 padlocks). Door locked when knob in position I, and when knob padlocked in position O.	GK3 AP03	0.300

(1) 1 voltage trip OR 1 fault signalling contact to be fitted inside the motor circuit-breaker.

Other versions

24 to 690 V, 50 or 60 Hz voltage trips for circuit-breakers **GV3 ME80**.
Please consult your Regional Sales Office.

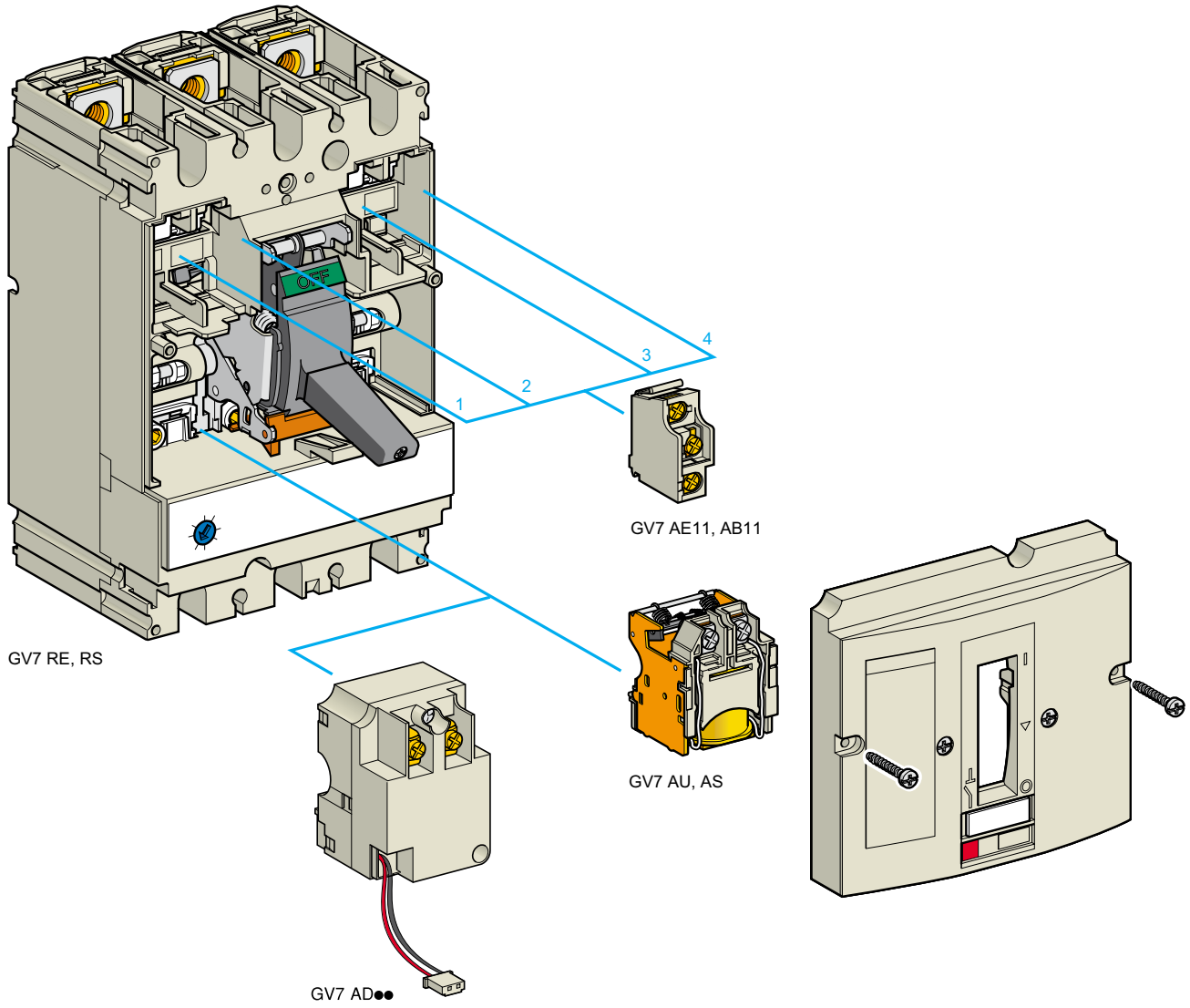

TeSys protection components

Thermal-magnetic motor circuit-breakers

GV7 R with screw clamp connections

Add-on blocks and accessories

Add-on auxiliary contacts

These allow remote indication of the circuit-breaker contact states. They can be used for signalling, electrical locking, relaying, etc. They are available in two versions: standard and low level. They include a terminal block and the auxiliary circuits leave the circuit-breaker through a hole provided for this purpose.

They perform the following functions, depending on where they are located in the circuit-breaker:

Location	Function	Application
1 and/or 4	C/O contact	Indicates the position of the circuit-breaker poles
2	Trip indication	Indicates that the circuit-breaker has tripped due to an overload, a short-circuit, a differential fault or the operation of a voltage trip (undervoltage or shunt trip), or of the "push to trip" test button. It resets when the circuit-breaker is reset.
3	Electrical fault indication	Indicates that the circuit-breaker has tripped due to an overload, a short-circuit or a differential fault. It resets when the circuit-breaker is reset.

Type	Reference	Weight kg
Standard	GV7 AE11	0.015
Low level	GV7 AB11	0.015

Fault discrimination devices

These make it possible to:

- either differentiate a thermal fault from a magnetic fault,
- or open the contactor only in the event of a thermal fault.

Voltage	Reference	Weight kg
~ 24...48 and ≍ 24...72 V	GV7 AD111 (1)	0.100
≍ 110...240 V	GV7 AD112 (1)	0.100

Electric trips

These allow the circuit-breaker to be tripped via an electrical control signal.

- Undervoltage trip GV7 AU
 - Trips the circuit-breaker when the control voltage drops below the tripping threshold, which is between 0.35 and 0.7 times the rated voltage.
 - Circuit-breaker closing is only possible if the voltage exceeds 0.85 times the rated voltage.
- Shunt trip GV7 AS
 - Trips the circuit-breaker when the control voltage rises above 0.7 times the rated voltage.
- Operation (GV7 AU or GV7 AS)
 - When the circuit-breaker has been tripped by a GV7 AU or AS, it must be reset either locally or by remote control. (For remote control, please consult your Regional Sales Office).
 - Tripping has priority over manual closing: if a tripping instruction is present, manual action does not result in closing, even temporarily, of the contacts.
 - Durability: 50 % of the mechanical durability of the circuit-breaker.

Type	Voltage	Reference	Weight kg
Undervoltage trip	48 V, 50/60 Hz	GV7 AU055 (1)	0.105
	110...130 V, 50/60 Hz	GV7 AU107 (1)	0.110
	200...240 V, 50/60 Hz	GV7 AU207 (1)	0.110
	380...440 V, 50/60 Hz	GV7 AU387 (1)	0.105
	525 V, 50 Hz	GV7 AU525 (1)	0.100
Shunt trip	48 V, 50/60 Hz	GV7 AS055 (1)	0.105
	110...130 V, 50/60 Hz	GV7 AS107 (1)	0.110
	200...240 V, 50/60 Hz	GV7 AS207 (1)	0.110
	380...440 V, 50/60 Hz	GV7 AS387 (1)	0.105
	525 V, 50 Hz	GV7 AS525 (1)	0.100

(1) For mounting of a GV7 AD or a GV7 AU or AS.

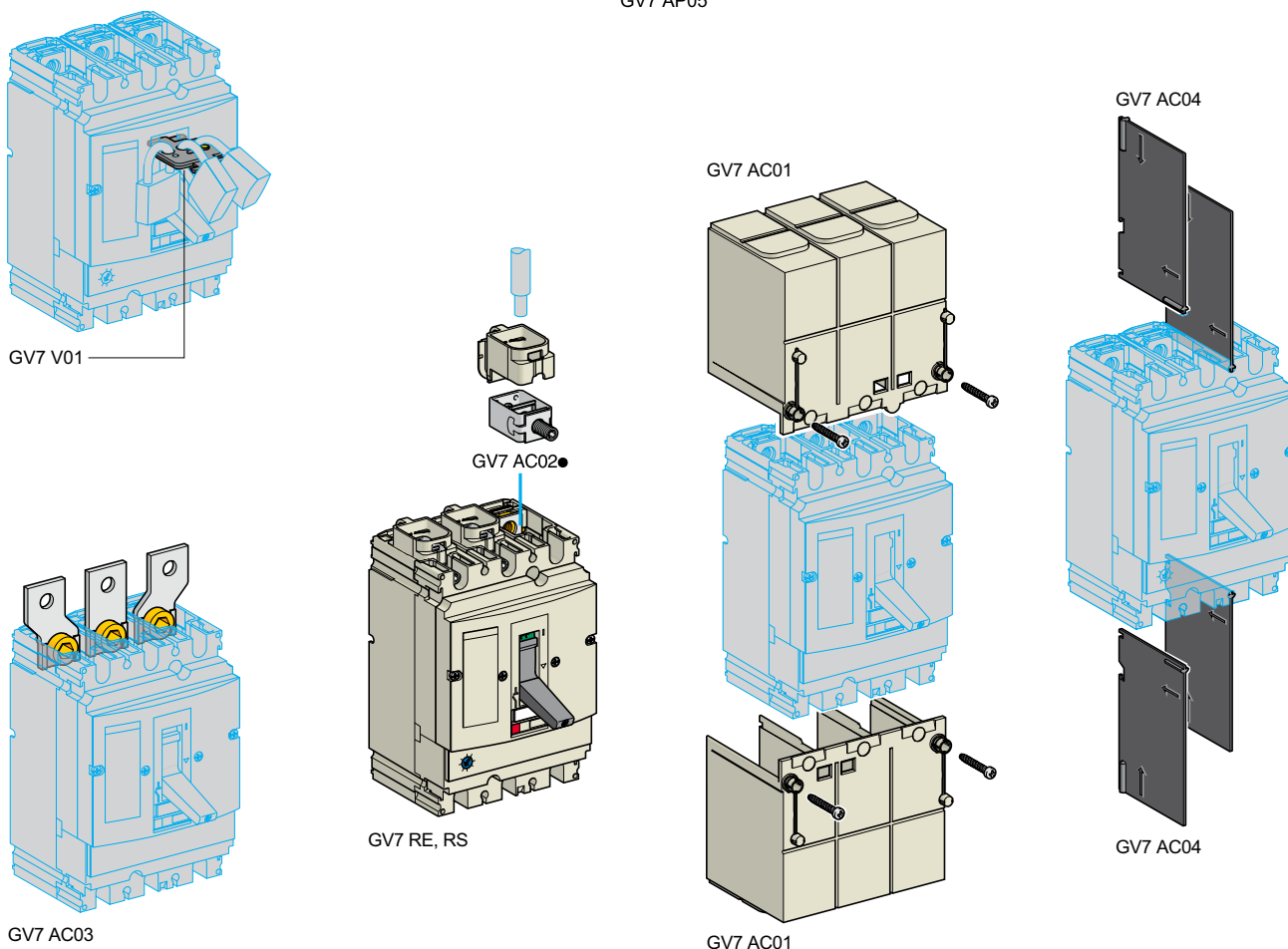
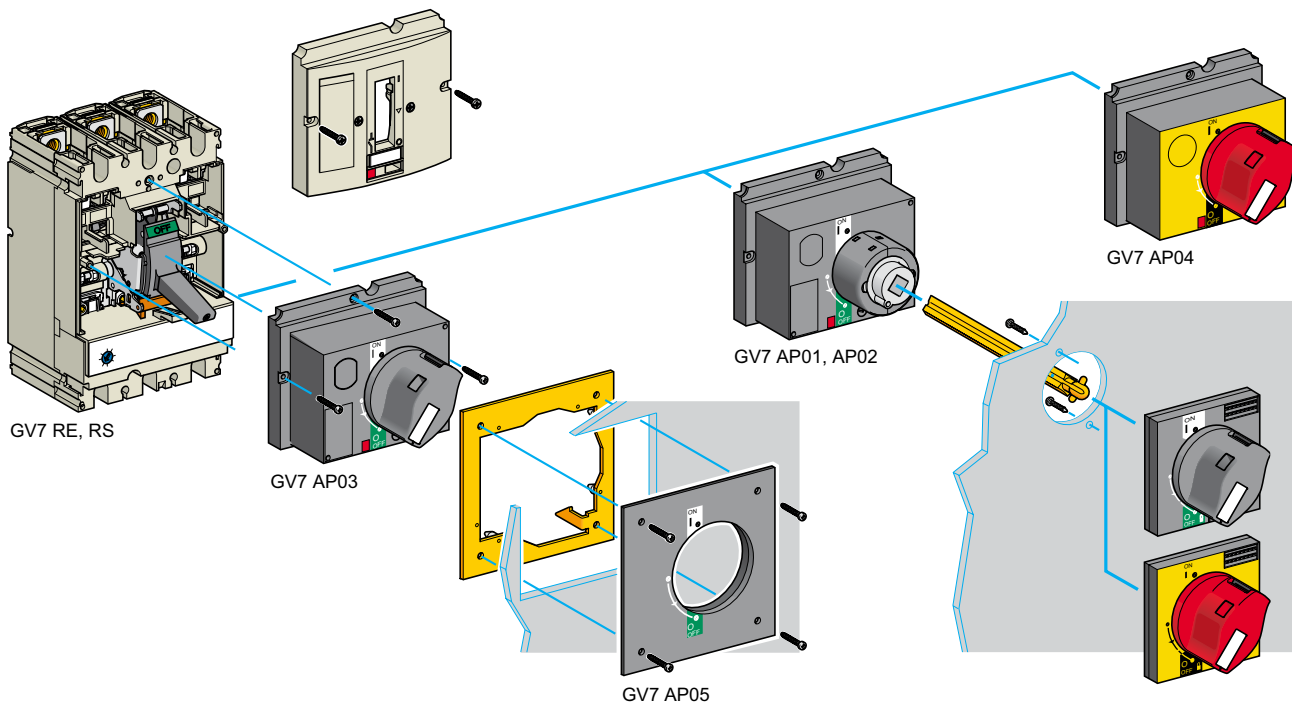

TeSys protection components

Thermal-magnetic motor circuit-breakers

GV7 R with screw clamp connections

Accessories

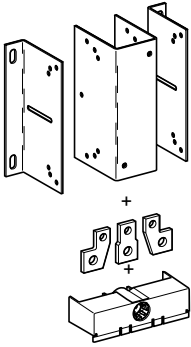

GV7 AC07

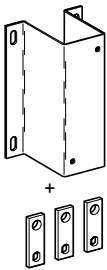

GV7 AC08

Cabling accessories

Description	Application	For use on contactors	Sold in lots of	Unit reference	Weight kg
Clip-on connectors for GV7 R	Up to 150 A, 1.5...95 mm ²	–	3	GV7 AC021	0.300
	Up to 220 A, 1.5...185 mm ²	–	3	GV7 AC022	0.350
Spreader 3-pole (1)	To increase the pitch to 45 mm	–	1	GV7 AC03	0.180
Terminal shields IP 405 (1)	Supplied with sealing accessory	–	1	GV7 AC01	0.125
Phase barriers	Safety accessories used when fitting of shields is impossible	–	2	GV7 AC04	0.075
Insulating screens	Ensure insulation between the connections and the backplate	–	2	GV7 AC05	0.075
Kits for combination with contactor(2)	Allowing link between the circuit-breaker and the contactor. The cover provides protection against direct finger contact	LC1 F115...F185	1	GV7 AC06	0.550
		LC1 F225 and F265	1	GV7 AC07	0.550
		LC1 D115 and D150	1	GV7 AC08	0.550

Direct rotary handle

Replaces the circuit-breaker front cover; secured by screws. It includes a device for locking the circuit-breaker in the O (Off) position by means of up to 3 padlocks with a shank diameter of 5 to 8 mm (padlocks not included). A conversion accessory allows the direct rotary handle to be mounted on the enclosure door. In this case, the door cannot be opened if the circuit-breaker is in the "ON" position. Circuit-breaker closing is inhibited if the enclosure door is open.

Description	Type	Degree of protection	Reference	Weight kg
Direct rotary handle	Black handle, black legend plate	IP 40	GV7 AP03	0.205
	Red handle, yellow legend plate	IP 40	GV7 AP04	0.205
Adapter plate (3)	Four mounting direct rotary handle on enclosure door	IP 43	GV7 AP05	0.100

Extended rotary handle

Allows a circuit-breaker installed in the back of an enclosure to be operated from the front of the enclosure. It comprises:

- a unit which screws onto the front cover of the circuit-breaker,
- an assembly (handle and front plate) to be fitted on the enclosure door,
- an extension shaft which must be adjusted (distance between the mounting surface and the door: 185 mm minimum, 600 mm maximum). It includes a device for locking the circuit-breaker in the O (Off) position by means of up to 3 padlocks with a shank diameter of 5 to 8 mm (padlocks not included). This prevents the enclosure door from being opened.

Description	Type	Degree of protection	Reference	Weight kg
Extended rotary handle	Black handle, black legend plate	IP 55	GV7 AP01	0.775
	Red handle, yellow legend plate	IP 55	GV7 AP02	0.775

Locking device

Allows circuit-breakers not fitted with a rotary handle to be locked in the O (Off) position by means of up to 3 padlocks with a shank diameter of 5 to 8 mm (padlocks not included).

Description	Application	Reference	Weight kg
Locking device	For circuit-breaker not fitted with a rotary handle	GV7 V01	0.100

(1) Terminal shields cannot be used together with spreaders.

(2) The kit comprises links, a protective shield and a depth adjustable metal bracket for the breaker.

(3) This conversion accessory makes it impossible to open the door if the device is closed and prevents the device from being closed if the door is open.

TeSys protection components

Thermal-magnetic motor circuit-breakers

GV2 ME and GV2 P

Dimensions

GV2 ME

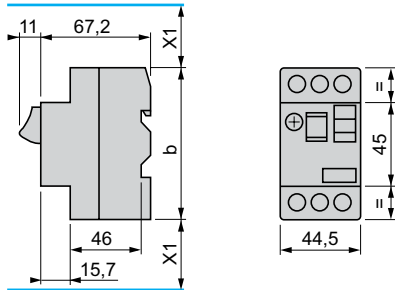

GV AX

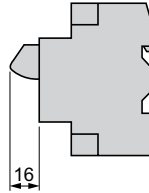

GV AD, AM, AN, AU, AS, AX

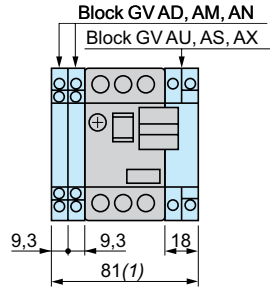

GV AE

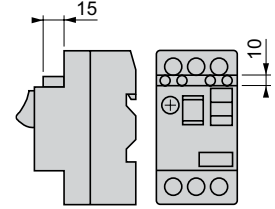

b

GV2 ME●●	89
GV2 ME●●3	101

(1) Maximum
X1 Electrical clearance = 40 mm for $U_e \leq 690$ V

GV2 P

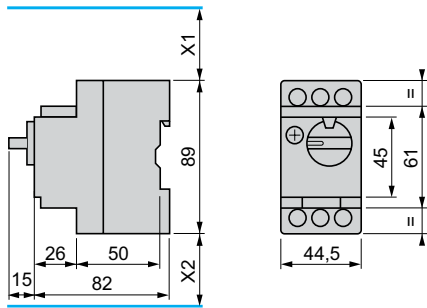

GV AD, AM, AN, AU, AS

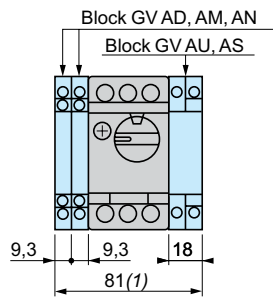

GV2 AK00

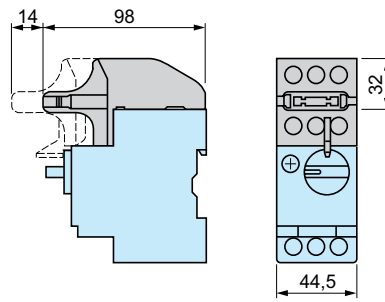

(1) Maximum
X1 Electrical clearance = 40 mm for $U_e \leq 415$ V, or 80 mm for $U_e = 440$ V,
or 120 mm for $U_e = 500$ and 690 V
X2 = 40 mm

GV2 GH7

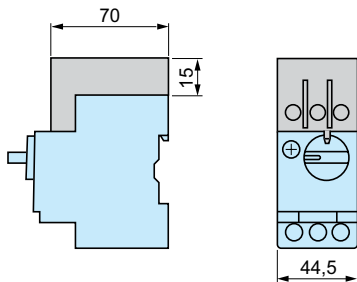

Mounting

GV2 ME

On 35 mm  rail

On panel with adapter plate GV2 AF02

On pre-slotted plate AM1 PA

On rails DZ5 MB201

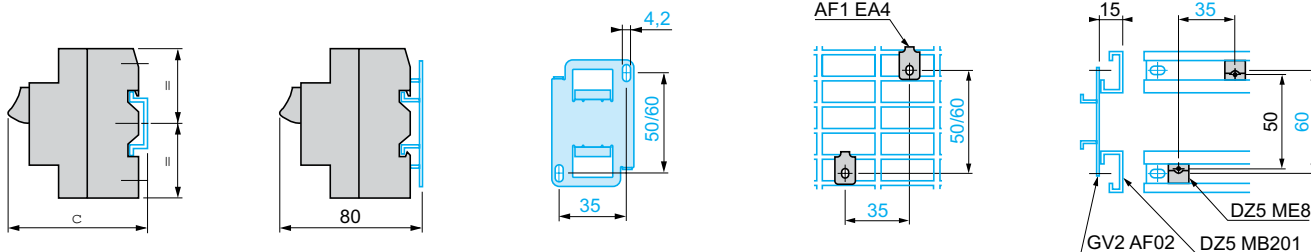

$c = 78.5$ on AM1 DP200 (35 x 7.5)
 $c = 86$ on AM1 DE200, ED200 (35 x 15)

GV2 P

On rail AM1 DE200, ED200 (35 x 15)

Panel mounted

On pre-slotted plate AM1 PA

Adapter plate GK2 AF01

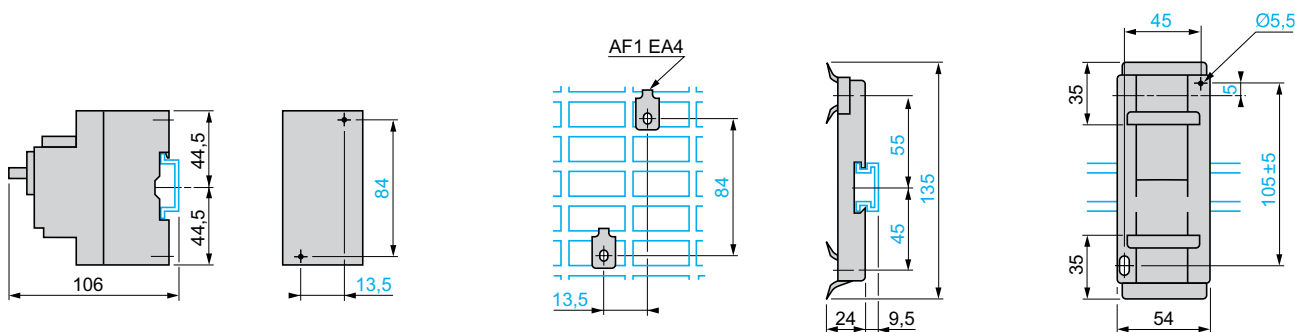

Dimensions

GV2 AF01

Combination GV2 ME + TeSys K contactor

GV2 AF3

Combination GV2 ME + TeSys D contactor

Combination GV2 P + TeSys D contactor

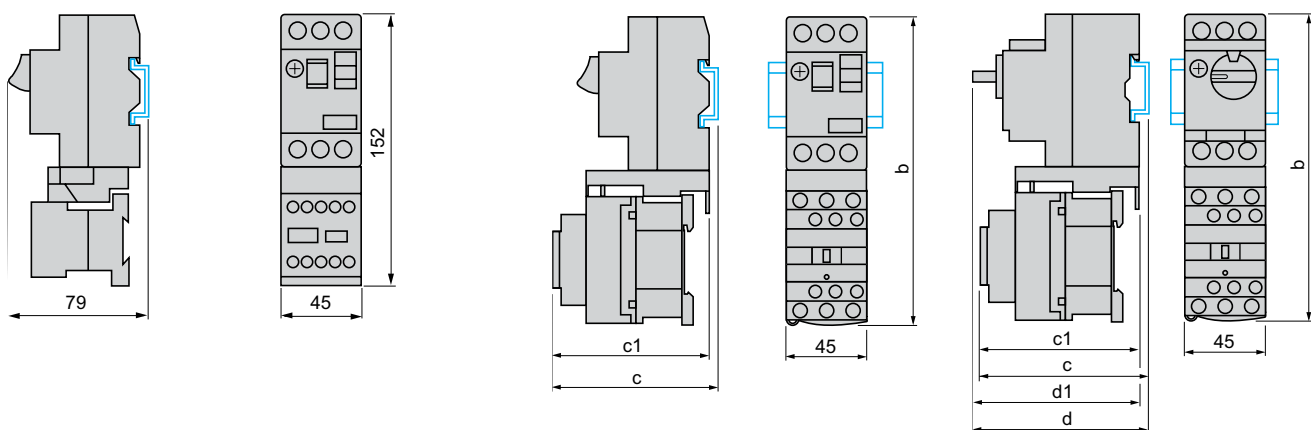

	GV2 ME + LC1 D09 ...D18	LC1 D25 and D32	GV2 P + LC1 D09 ...D18	LC1 D25 and D32
b	176.4	186.8	176.4	186.8
c1	94.1	100.4	100.1	106.4
c	99.6	105.9	105.6	111.9
d1			95	95
d			100.5	100.5

Dimensions (continued)

GV2 AF4 + LAD 311

Combination GV2 ME + TeSys D contactor

Combination GV2 P + TeSys D contactor

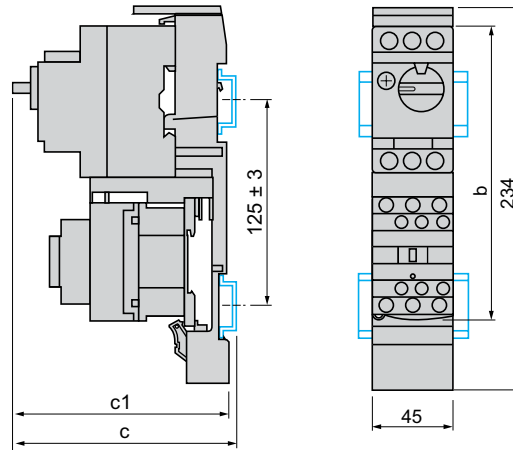
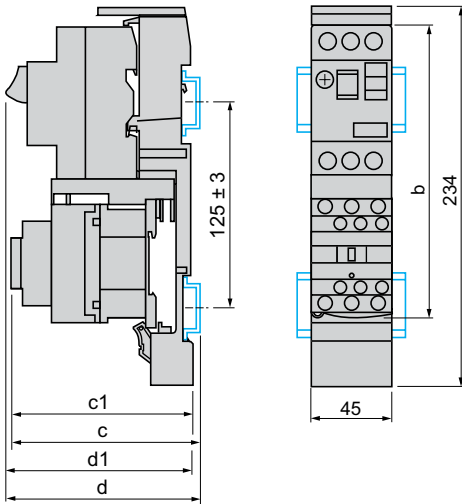

GV2 ME +	LC1 D09...D18	LC1 D25 and D32
b	176.4	186.8
c1	103.1	136.4
c	135.6	141.9
d1	107	107
d	112.5	112.5

GV2 P +	LC1 D09...D18	LC1 D25 and D32
b	176.4	186.8
c1	136.5	142.4
c	141.6	147.9

GV2 ME + GV1 L3 (current limiter)

7.5 mm height compensation plate GV1 F03

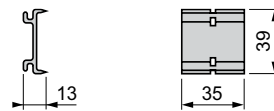
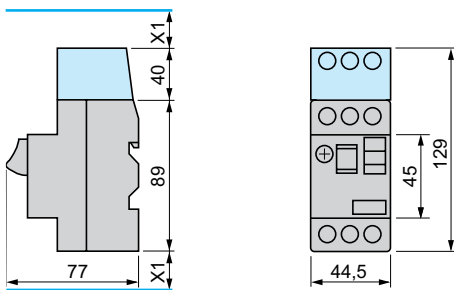

X1 = 10 mm for Ue = 230 V
or 30 mm for 230 V < Ue ≤ 690 V

Mounting

Mounting of external operator GV2 AP01 or GV2 AP02 for motor circuit-breakers GV2 P

Door cut-out

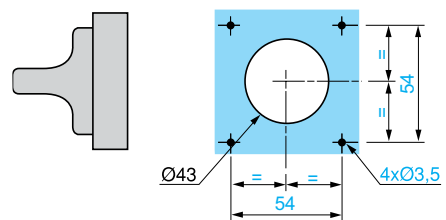
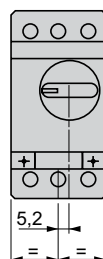
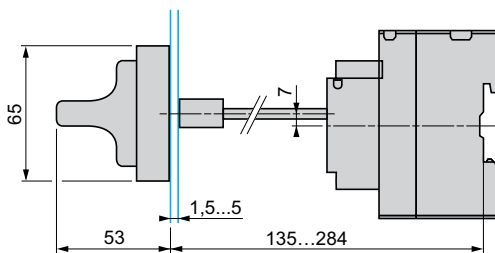

GV2 ME, GV2 P

Sets of busbars GV2 G445, GV2 G454, GV2 G472, with terminal block GV2 G05

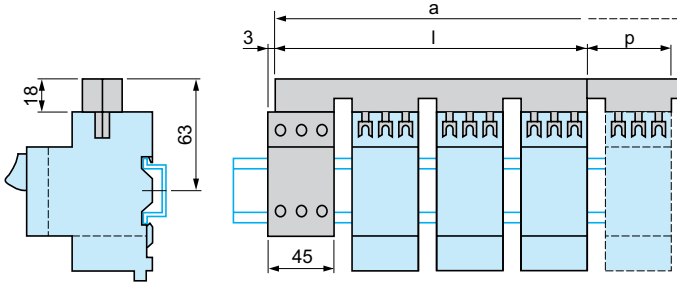

	l	p
GV2 G445 (4 x 45 mm)	179	45
GV2 G454 (4 x 54 mm)	206	54
GV2 G472 (4 x 72 mm)	260	72

Number of tap-offs	a			
	5	6	7	8
GV2 G445	224	269	314	359
GV2 G454	260	314	368	422
GV2 G472	332	404	476	548

Sets of busbars GV2 G●●● with terminal block GV1 G09

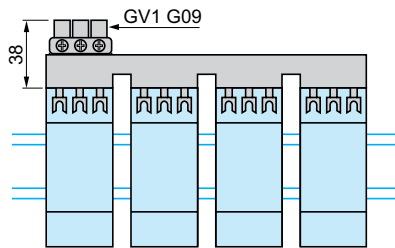

	l
GV2 G245 (2 x 45 mm)	89
GV2 G254 (2 x 54 mm)	98
GV2 G272 (2 x 72 mm)	116

Sets of busbars GV2 G245, GV2 G254, GV2 G272

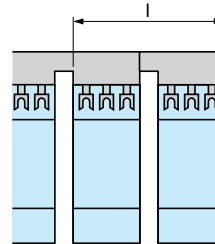

Sets of busbars GV2 G554

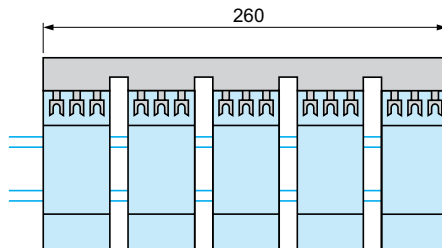

	l
GV2 G345 (3 x 45 mm)	134
GV2 G354 (3 x 54 mm)	152

Sets of busbars GV2 G345 and GV2 G354

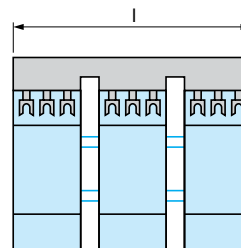

3

GV2 RT

Dimensions

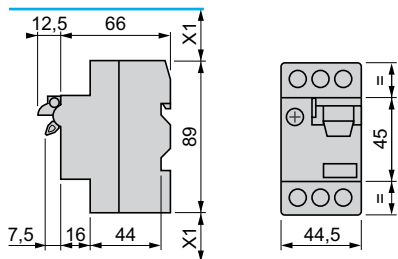

X1: Electrical clearance = 40 mm for $U_e < 690$ V

Mounting

Mounting of external operator GV2 AP03

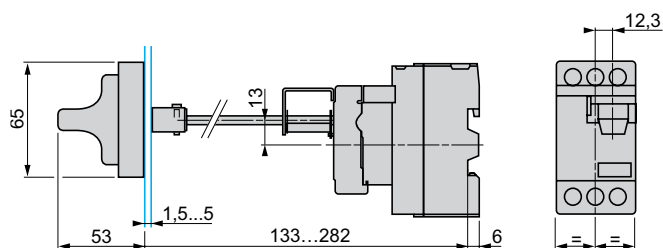

On 35 mm rail

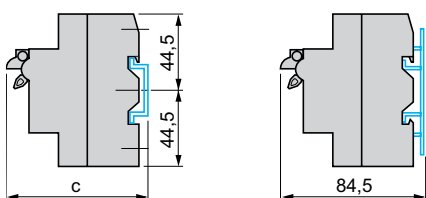

$c = 80$ on AM1 DP200 (35 x 7.5)
 $c = 88$ on AM1 DE200, ED200 (35 x 15)

On panel with adapter plate GV2 AF02

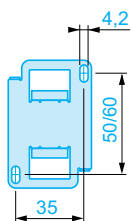

On pre-slotted plate AM1 PA

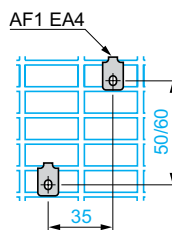

On rails DZ5 MB

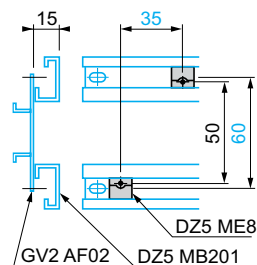

GV3 P

Dimensions

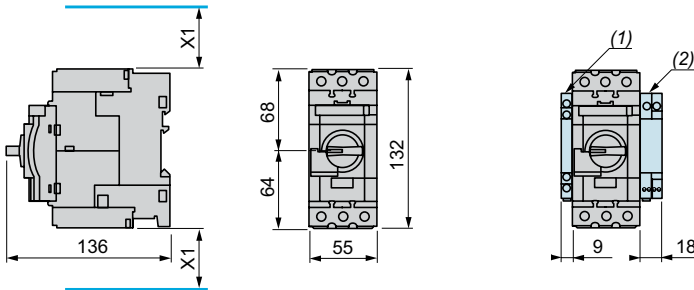

X1 = Electrical clearance (ISC max)
40 mm for $U_e \leq 500$ V, 50 mm for $U_e \leq 690$ V

(1) Blocks GV AN●●, GV AD●● and GV AM11
(2) Blocks GV3 AU●● and GV3 AS●●

Note: Leave a gap of 9 mm between 2 circuit-breakers: either an empty space or side-mounting add-on contact blocks.
Horizontal mounting is possible up to 40 °C

Mounting

Mounting with TeSys contactor LC1 D40A...D65A

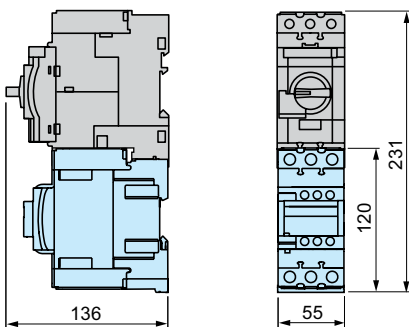

Side by side mounting with TeSys contactor LC1 D40A...D65A (S-shape busbar system GV3 S)

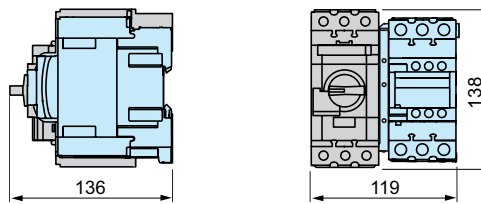

Mounting on rail AM1 DE200 or AM1 ED201

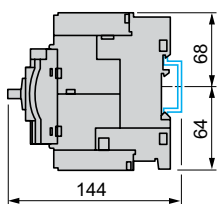

Panel mounting, using M4 screws

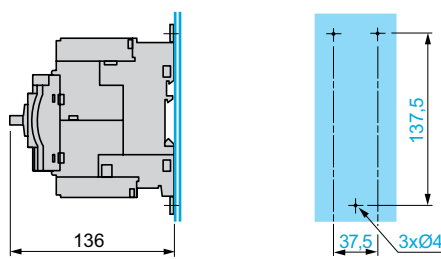

Mounting on pre-slotted plate AM1 PA

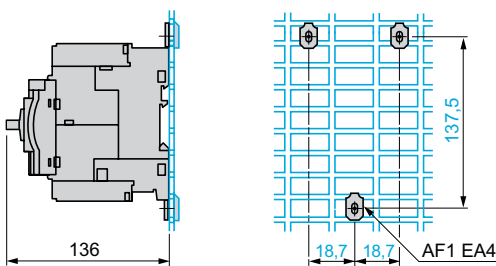

GV3 P (continued)

Busbar systems

Set of busbars GV3 G264

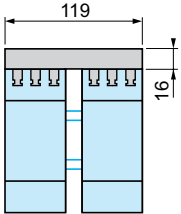

Set of busbars GV3 G364

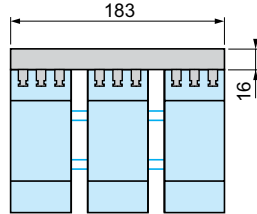

Note: Leave a space of 9 mm between 2 circuit-breakers: either an empty space or side-mounting add-on contact blocks.
Horizontal mounting is possible up to 40 °C.

Mounting of external operator GV3 AP01 or GV3 AP02

Depth 131 mm

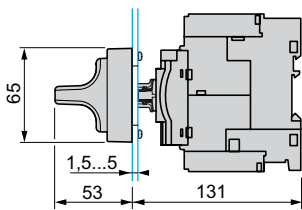

Depth 231 to 390 mm

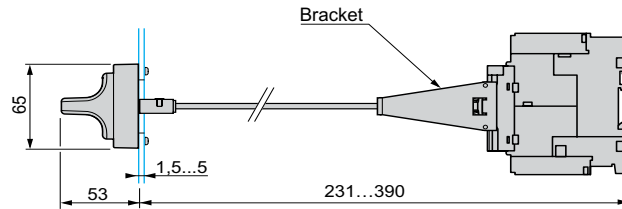

Depth 177 to 230 mm

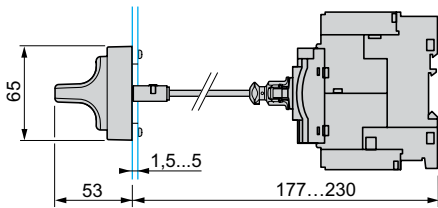

Door cut-out

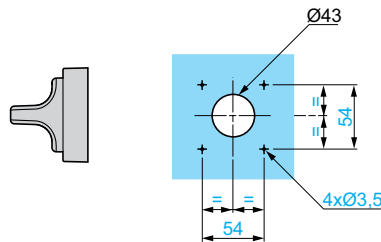

GV3 ME80

Dimensions

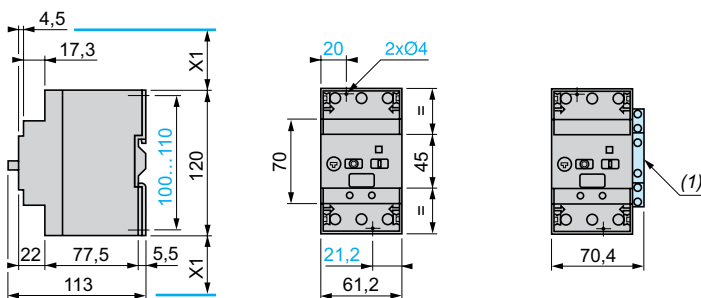

X1 = Electrical clearance (ISC max)
40 mm for $U_e \leq 500$ V, 50 mm for $U_e \leq 690$ V

(1) Blocks GV3 A01...A07.

Mounting

Mounting on rail AM1 DE200 or AM1 ED201

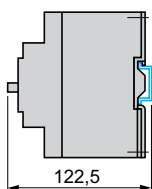

Panel mounting, using M4 screws

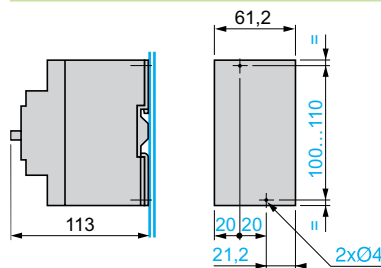

Mounting on pre-slotted plate AM1 PA

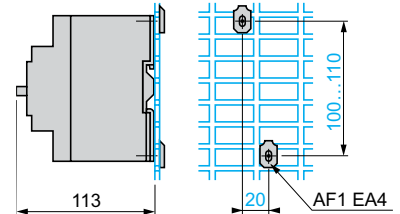

GV7 R

Dimensions

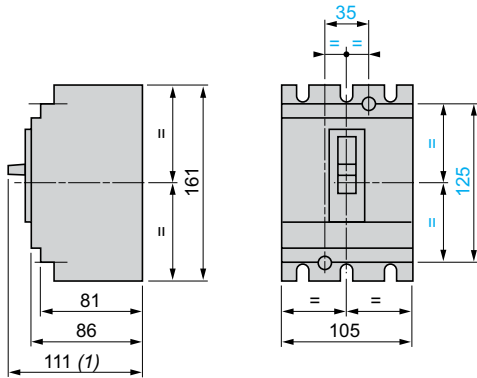

(1) 126 for GV7 R•220.

Motor circuit-breakers with terminal shields or phase barriers GV7 R + GV7 AC01 or AC04

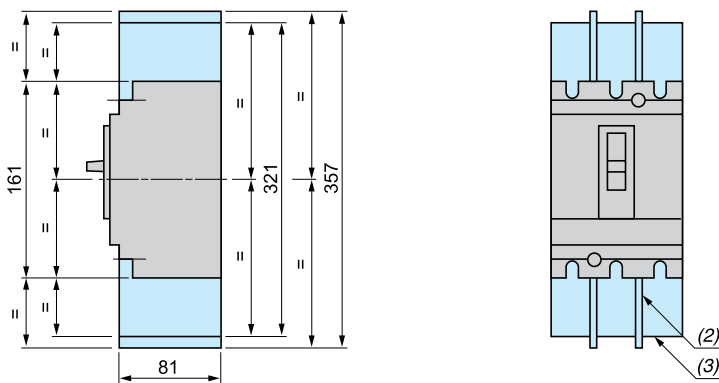

(2) Phase barriers: **GV7 AC04**
(3) Terminal shields: **GV7 AC01**

Combination of GV7 R and TeSys contactor LC1 F with kit GV7 AC0•

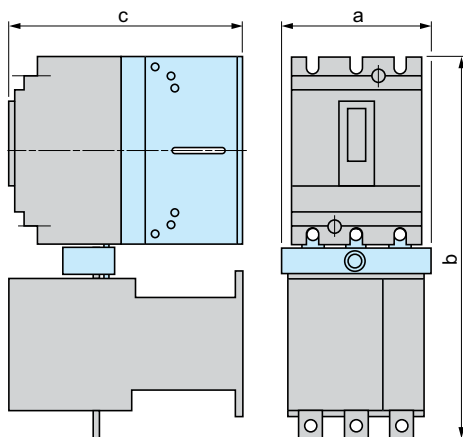

	a	b	c
GV7 R + LC1 F115 or F150 + GV7 AC06	119	334	181
GV7 R + LC1 F185 + GV7 AC06	119	338	188
GV7 R + LC1 F225 + GV7 AC07	131	358	188
GV7 R + LC1 F265 + GV7 AC07	131	364	215

Minimum distance between 2 circuit-breakers mounted side by side = 0

Minimum electrical clearance

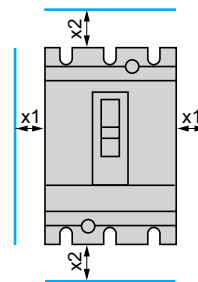

	x1	x2
Painted or insulated metal plate, insulation or insulated bar	0	30
Bare metal plate	U ≤ 440 V	5
	440 V < U < 600 V	10
	U ≥ 600 V	20

GV7 R

Panel mounting

Mounting on 2 mounting rails DZ5 MB201

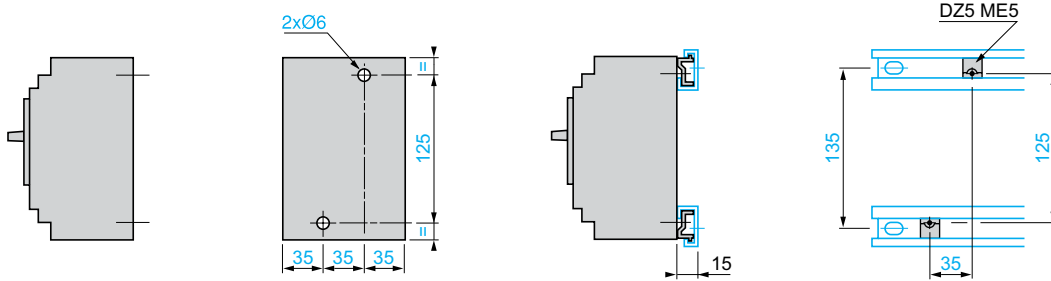

3

Flush-mounting

1 circuit-breaker GV7 R

n circuit-breakers GV7 R
side by side

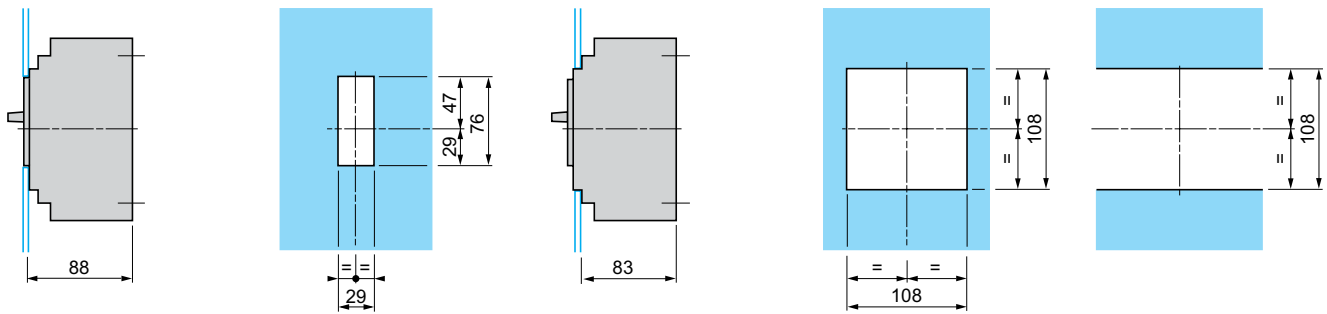

Combination of GV7 R and TeSys contactor LC1 F with kit GV7 AC0●

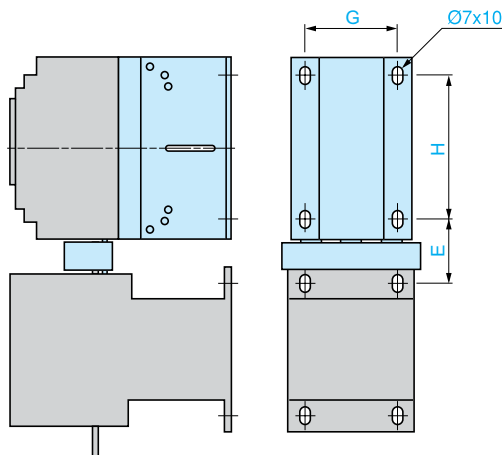

	E	G	H
GV7 R + LC1 F115 + GV7 AC06	44	85	120
GV7 R + LC1 F150 + GV7 AC06	46	85	120
GV7 R + LC1 F185 + GV7 AC06	48	85	120
GV7 R + LC1 F225 + GV7 AC07	57	85	120
GV7 R + LC1 F265 + GV7 AC07	60	85	120

GV7 R

Spreaders GV7 AC03

Connection

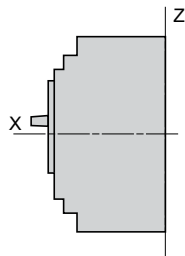
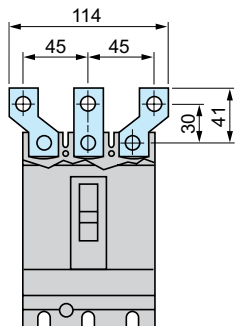

Smooth terminals

Connectors

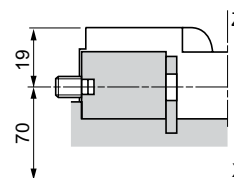
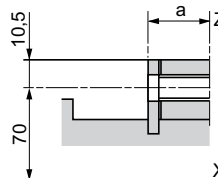

	a
GV7 Rø40...Rø150	19.5
GV7 Rø220	21.5

Direct rotary handle GV7 AP03, GV7 AP04

Flush-mounting

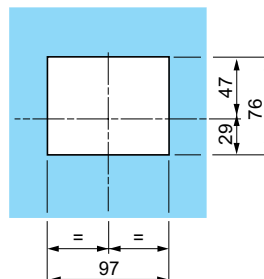
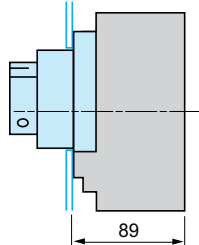
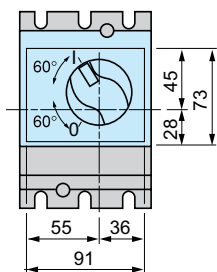
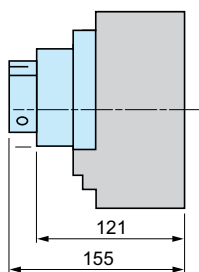

Direct rotary handle GV7 AP03 or GV7 AP04 with conversion accessory GV7 AP05

Front face cut-out

Enclosure viewed from top

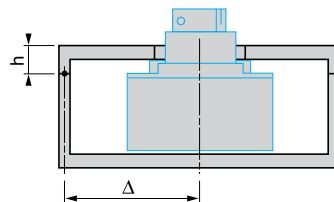
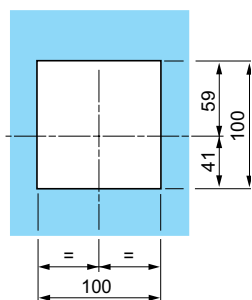
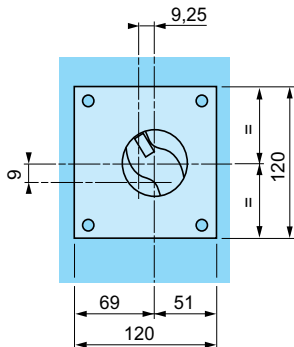
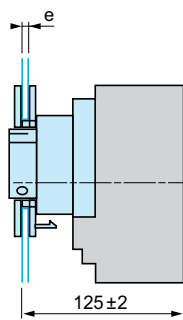

Door cut-outs require a minimum distance between the centre of the circuit-breaker and the door hinge point $\Delta \geq 100 + (h \times 5)$

e = 1 to 3 max

Extended rotary handle GV7 AP01, GV7 AP02

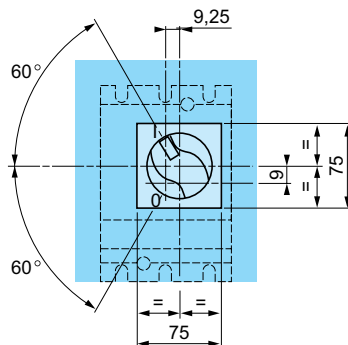
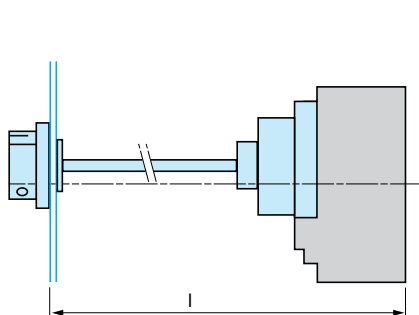

l: 185 min, 600 max

The shaft of the extended rotary handle GV7 AP01 or GV7 AP02 must be cut to length: l – 126 mm.

Schemes

GV2 ME●● and GV2 RT

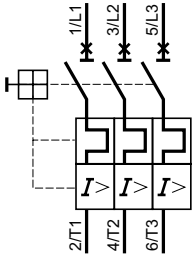

GV2 P●●

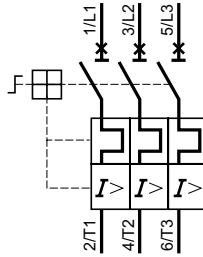

GV3 P●●

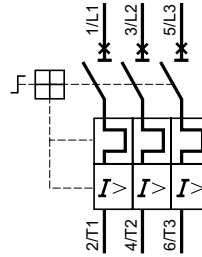

Front mounting add-on contact blocks Instantaneous auxiliary contacts

GV AE1

GV AE11

GV AE20

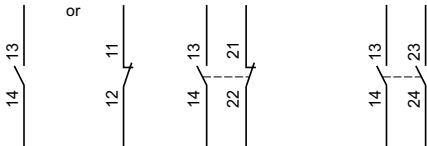

Front mounting add-on contact blocks Instantaneous auxiliary contacts and fault signalling contacts

GV AED101

GV AED011



Side mounting add-on contact blocks Instantaneous auxiliary contacts and fault signalling contacts

GV AD0110

GV AD0101

GV AD1010

GV AD1001



Instantaneous auxiliary contacts

GV AN11

GV AN20



Short-circuit signalling contacts

GV AM11

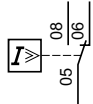

Voltage trips

GV AU●●●

GV AS●●●

GV AX●●●

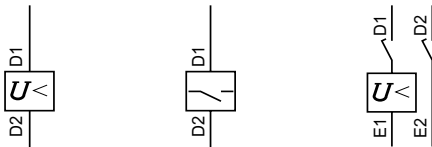

Current limiter

GV1 L3

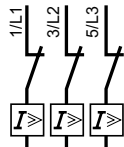

Use of fault signalling contact and short-circuit signalling contact

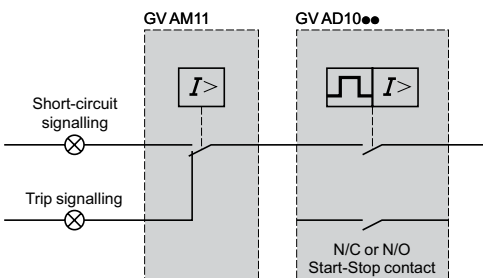

Connection of undervoltage trip for dangerous machines (conforming to INRS) on GV2 ME only

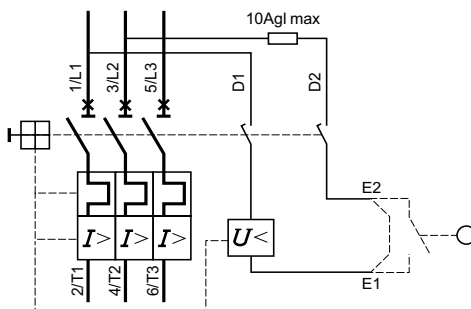

3

Schemes

Motor circuit-breakers

GV3 ME80

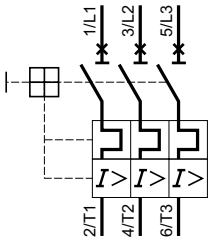

Auxiliary contact block modules

GV3 A01



GV3 A02



GV3 A03

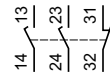

GV3 A05

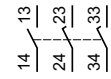

GV3 A06

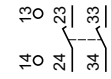

GV3 A07

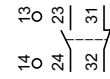

Fault signalling contacts

GV3 A08

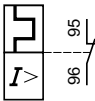

GV3 A09

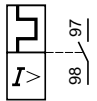

Voltage trips

GV3 B



GV3 D



Motor circuit-breakers

GV7 R

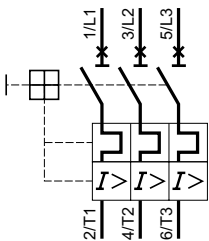

Add-on auxiliary contacts according to their location (1)

GV7 AE11, GV7 AB11

Location 1 C/O contact



Location 2 Trip indication



Location 3 Electrical fault indication



Location 4 C/O contact



A self-adhesive label, supplied with the contact, can be affixed to the front face of the circuit-breaker to allow personalised marking according to the function of the contact or contacts.
(1) See pages 3/20 and 3/61.

Electric trips

GV7 AU●●●

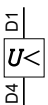

GV7 AS●●●

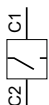

GV7 AD111, AD112

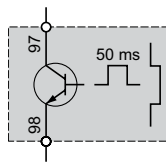

Recommended application schemes GV7 AD111, AD112

Fault indication

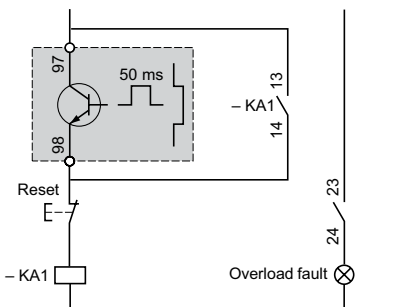

Contact opening on overload

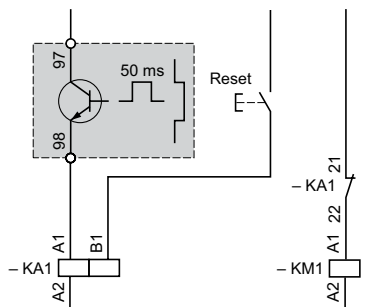

Associated components
KA1: CA2 KN or CAD N

Associated components
KA1: CAD + LAD 6K10 or RHK
KM1: LC1 D or LC1 F

3

GV2 L

Dimensions

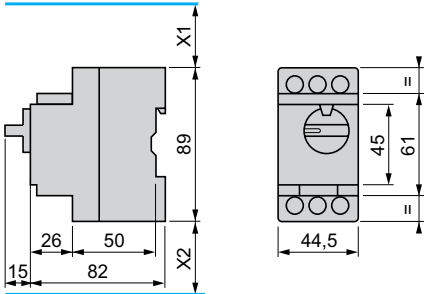

GV AD, AM, AN, AU, AS

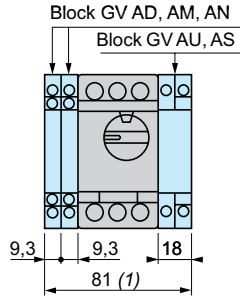

GV2 AK00

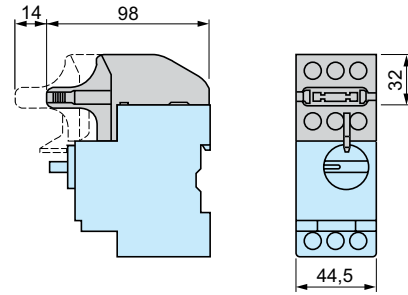

X1 Electrical clearance = 40 mm for $U_e \leq 415$ V, or 80 mm for $U_e = 440$ V, or 120 mm for $U_e = 500$ and 690 V.
X2 = 40 mm.

(1) Maximum

Mounting

On rail AM1 DE200,
AM1 ED200 (35 x 15)

Panel mounted

On pre-slotted mounting
plate AM1 PA

Adapter plate GK2 AF01

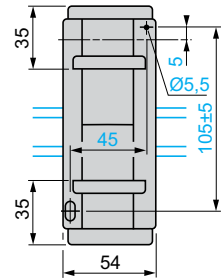
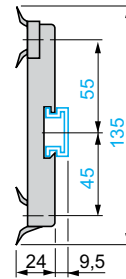
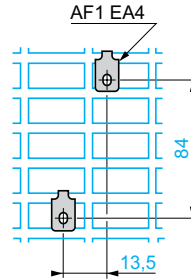
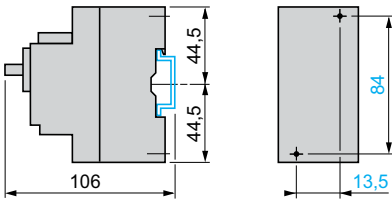

7.5 mm height compensation plate GV1 F03



GV2 LE

Dimensions

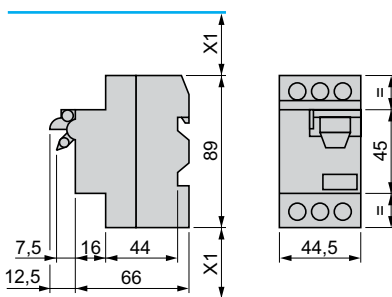

GV AD, AM, AN, AU, AS

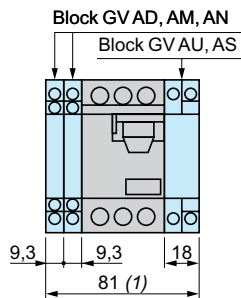

GV AE

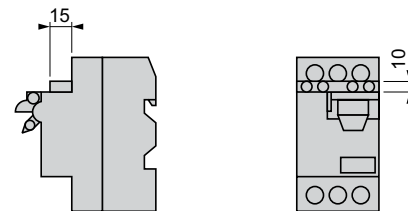

X1 Electrical clearance = 40 mm for $U_e \leq 690$ V.

(1) Maximum

Mounting

On 35 mm rail

On panel with adapter plate GV2 AF02

On pre-slotted plate AM1 PA

On rails DZ5 MB201

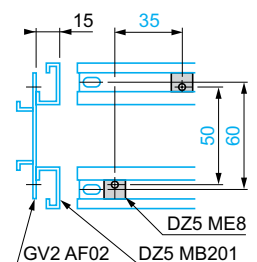
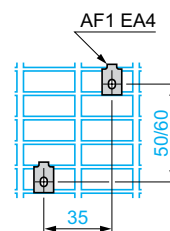
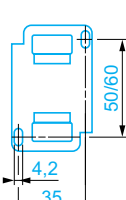
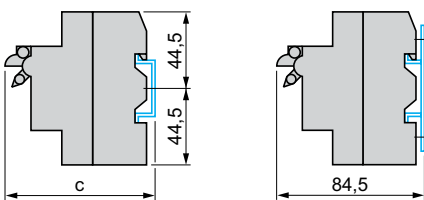

c = 80 on AM1 DP200
(35 x 7.5) and 88 on
AM1 DE200, ED200 (35 x 15)

GV2 L and GV2 LE

Mounting of external operator GV2 AP01 or GV2 AP02 for GV2 L

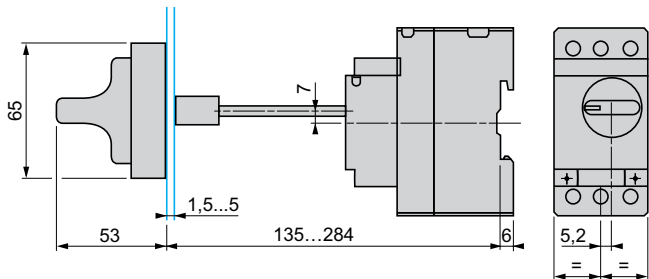

Mounting of external operator GV2 AP03 for GV2 LE

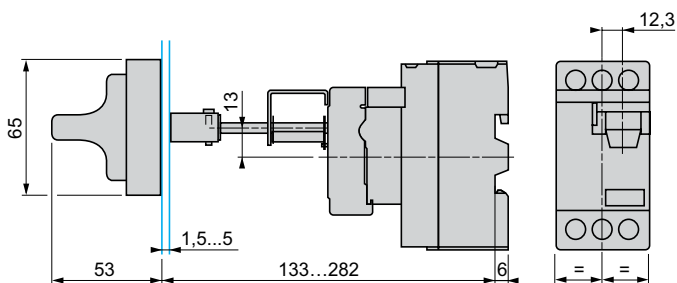

Door cut-out

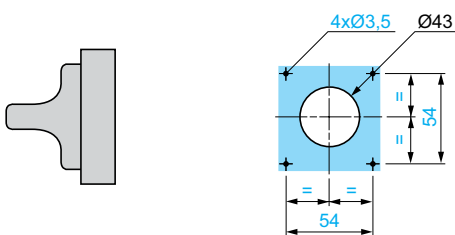

Sets of busbars GV2 G445, GV2 G454, GV2 G472, with terminal block GV2 G05

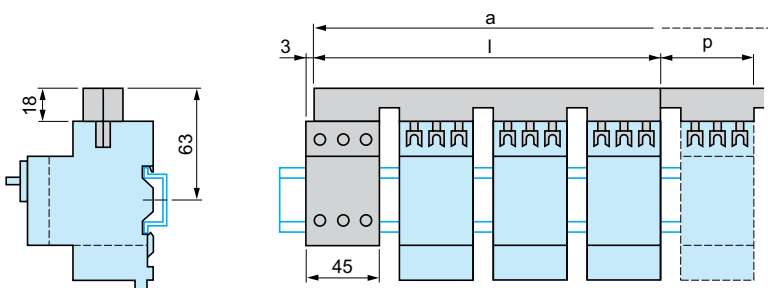

	l	p
GV2 G445 (4 x 45 mm)	179	45
GV2 G454 (4 x 54 mm)	206	54
GV2 G472 (4 x 72 mm)	260	72

	a			
Number of tap-offs	5	6	7	8
GV2 G445	224	269	314	359
GV2 G454	260	314	368	422
GV2 G472	332	404	476	548

Sets of busbars for GV2 L and GV2 LE

Sets of busbars GV2 G●●● with term. block GV1 G09

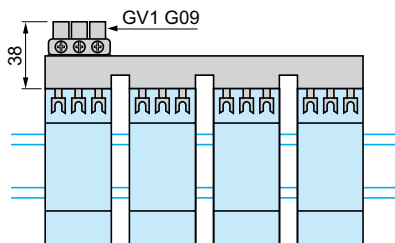

Sets of busbars GV2 G245, GV2 G254, GV2 GR272

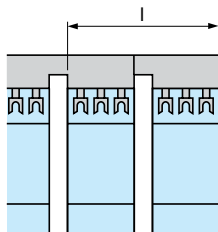

3

	l
GV2 G245 (2 x 45 mm)	89
GV2 G254 (2 x 54 mm)	98
GV2 G272 (2 x 72 mm)	116

Set of busbars GV2 G554

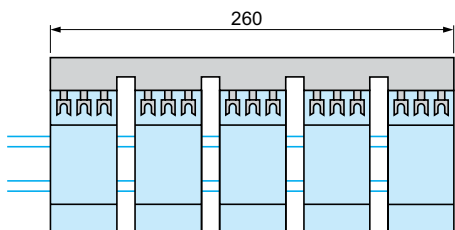

Sets of busbars GV2 G345 and GV2 G354

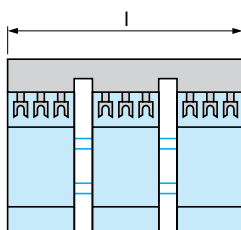

	l
GV2 G345 (3 x 45 mm)	134
GV2 G354 (3 x 54 mm)	152

GV3 L

Dimensions

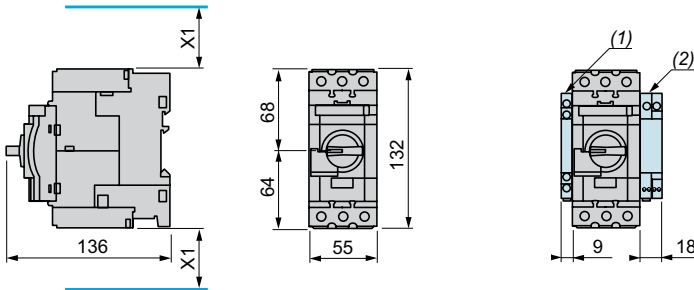

X1 = Electrical clearance (ISC max)
40 mm for $U_e \leq 500$ V, 50 mm for $U_e \leq 690$ V

(1) Blocks GV AN●●, GV AD●● and GV AM11
(2) Blocks GV3 AU●● and GV3 AS●●

Note: Leave a space of 9 mm between 2 circuit-breakers: either an empty space or side-mounting add-on contact blocks.
Side by side mounting is possible up to 40 °C.

3

Mounting

Mounting with Tesys contactor LC1 D40A...D65A and relay LR3 D313...365

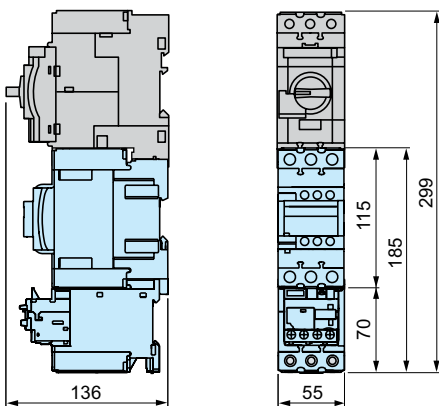

Side by side mounting with Tesys contactor LC1 D40A...D65A (S-shape busbar system GV3 S)

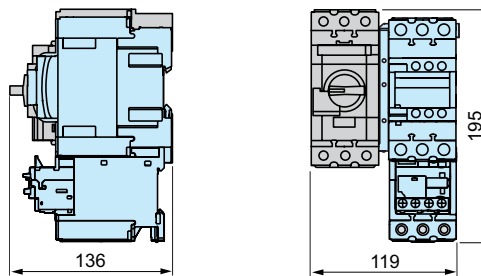

Mounting on rail AM1 DE200 or AM1 ED201

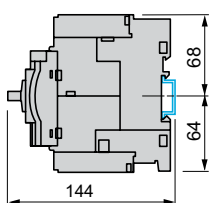

Panel mounting, using M4 screws

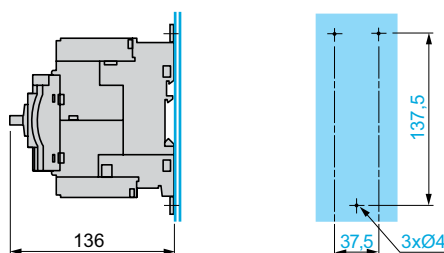

Mounting on pre-slotted plate AM1 PA

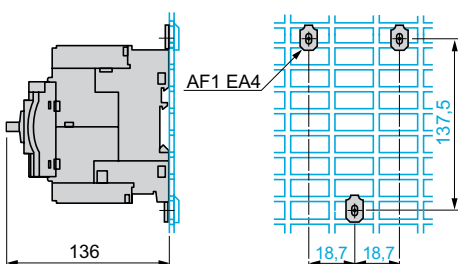

Set of busbars GV3 G264

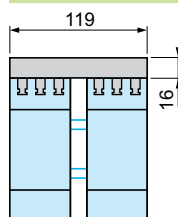

Set of busbars GV3 G364

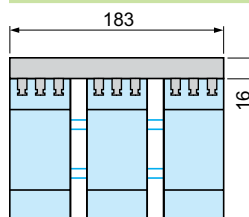

GV3 L (continued)

Mounting of external operator GV3 AP01 or GV3 AP02

Depth 131 mm

Depth 231 to 390 mm

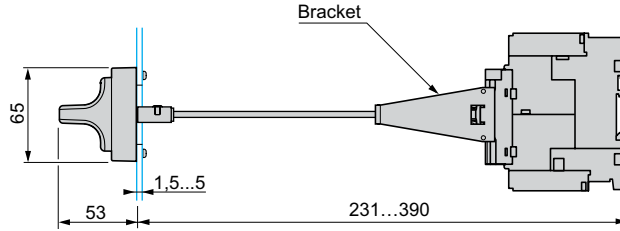
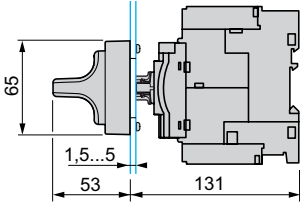

3

Depth 177 to 230 mm

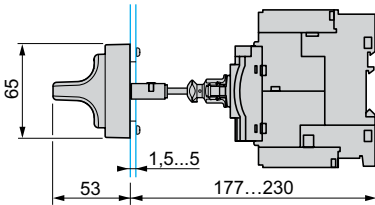

Door cut-out

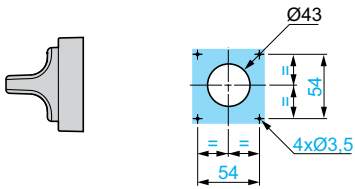

GK3 EF80

GK3 EF80 + 4 GK2 AX

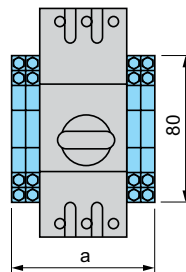
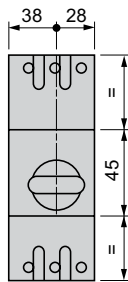
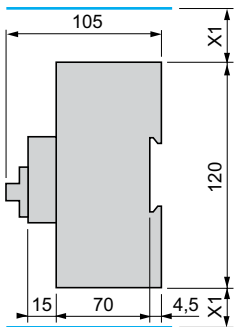

	Number of GK2 AX				
	0	1	2	3	4
a	66	74.8	83.5	92.5	101

Magnetic motor circuit-breakers

GV2 L●●

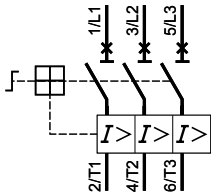

GV2 LE●●

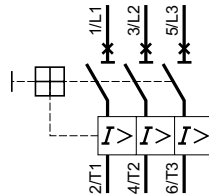

GV3 L●●

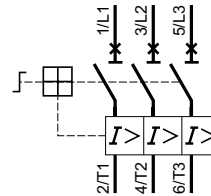

GK3 EF80

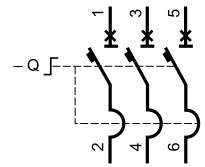

Accessories

Front mounting add-on contact blocks

Instantaneous auxiliary contacts

GV AE1

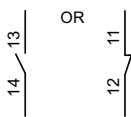

GV AE11

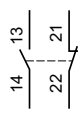

GV AE20

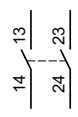

GV AED101 and GV AED011

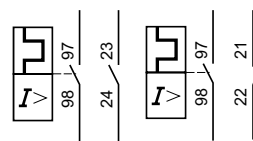

Side mounting add-on contact blocks

Instantaneous auxiliary contacts and fault signalling contacts

GV AD0110

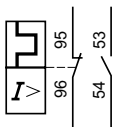

GV AD0101

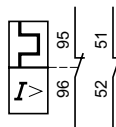

GV AD1010

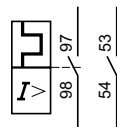

GV AD1001

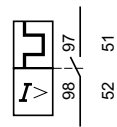

Instantaneous auxiliary contacts

GV AN11

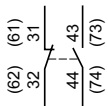

GV AN20

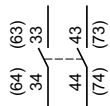

Short-circuit signalling contacts

GV AM11

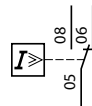

Voltage trips

GV AU●●●

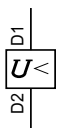

GV AS●●●



Start-Stop signalling contact blocks

GK2 AX10



GK2 AX20

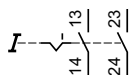

GK2 AX50

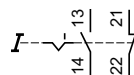

Fault signalling contact blocks

GK2 AX12



GK2 AX22

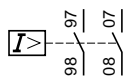

GK2 AX52

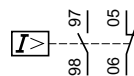

TeSys protection components

Thermal-magnetic circuit-breakers TeSys GB2 for the protection of control circuits, solenoid valves and transformers

Applications

Protection of industrial equipment control circuits and of single-phase loads

3



Tripping threshold on short-circuit	5...7 I_n	12...16 I_n	
Operational current	0.5 and 1 A	0.5...20 A	
Maximum operational voltage	415 V		250 V
Number of poles	1		1 + neutral
Breaking capacity (I_{cu}) conforming to IEC 60947-2	50 kA at 415 V	1.5...50 kA at 415 V	1.5...50 kA at 250 V
Device type	GB2 C	GB2 CB	GB2 CD
Pages	3/91	3/90	3/90

Protection of transformers

Single-phase ≤ 5000 VA/415 V

3-phase ≤ 10 kVA/415 V

Primary

Secondary



3

			About 20 In
			0.25...23 A
415 V			690 V
2		1 + neutral	3
1.5...50 kA at 415 V		1.5...50 kA at 250 V	15...100 kA at 415 V
GB2 DB	GB2 DB	GB2 CD	GV2 RT
3/90	3/90	3/90	3/50

TeSys protection components

Thermal-magnetic circuit-breakers TeSys GB2 for the protection of industrial equipment control circuits

Presentation

GB2 thermal-magnetic circuit-breakers protect and isolate the control circuits of industrial equipment with contactor coils, transformers...
They protect and isolate single-phase auxiliary circuits such as solenoid valves, electro-brakes, battery chargers, supplied from the control circuit voltage.

GB2 CB, GB2 CD, GB2 DB

12 ratings are available, from 0.5 to 20 A, in single-pole (GB2 CB), single-pole + neutral (GB2 CD) and 2-pole (GB2 DB) versions.
They have a magnetic tripping threshold set at between 12 and 16 In to withstand the current peaks generated by many industrial components.

GB2 CS

2 ratings are available, 0.5 and 1 A, in single-pole version.
The magnetic tripping threshold is set between 5 and 7 In.

Functions, installation

Clip-on fixing onto all types of 35 mm \perp rails, on \perp rails and on Telequick mounting plates.
Upstream and downstream marking by means of AB1 clip-in markers.
Clear indication of "I" and "O" positions on the operator.
Tamper-proof device which requires no special maintenance (fixed magnetic and thermal tripping thresholds).

Selection for the protection of circuits supplied by transformers

Single-phase transformers.
Magnetising peak: 20 In.
Operation of magnetic trips: 13 In.

Power VA	Primary (1)		Secondary			
	220/240 V	380/415 V	24 V	48 V	110 V	220 V
40	GB2 DB05	GB2 DB05	GB2 CD07	GB2 CD06	GB2 CD05	GB2 CD05
63	GB2 DB05	GB2 DB05	GB2 CD08	GB2 CD07	GB2 CD06	GB2 CD05
100	GB2 DB06	GB2 DB05	GB2 CD10	GB2 CD07	GB2 CD06	GB2 CD05
160	GB2 DB07	GB2 DB06	GB2 CD14	GB2 CD09	GB2 CD07	GB2 CD06
250	GB2 DB07	GB2 DB06	GB2 CD16	GB2 CD12	GB2 CD08	GB2 CD07
400	GB2 DB08	GB2 DB07	GB2 CD22	GB2 CD14	GB2 CD09	GB2 CD07
630	GB2 DB10	GB2 DB08	–	GB2 CD21	GB2 CD12	GB2 CD08
1000	GB2 DB14	GB2 DB09	–	–	GB2 CD16	GB2 CD10
1600	GB2 DB20	GB2 DB14	–	–	–	GB2 CD14
2000	GB2 DB21	GB2 DB14	–	–	GB2 CD22	GB2 CD16
2500	GB2 DB22	GB2 DB20	–	–	–	GB2 CD20
3000	GB2 DB22	GB2 DB20	–	–	–	GB2 CD21
4000	–	GB2 DB21	–	–	–	GB2 CD22
5000	–	GB2 DB22	–	–	–	–

(1) If the breaking capacity of the GB2 is insufficient, use a GV2 RT with 2 poles connected in series, see page 3/50.

TeSys protection components

Thermal-magnetic circuit-breakers TeSys GB2 for the protection of industrial equipment control circuits

Circuit-breaker type		GB2 CB	GB2 CD	GB2 DB	GB2 CS
Environment					
Conforming to standards		IEC 60947-1, 947-2, EN 60947-1, 60947-2			
Product certifications		CSA, NEMKO, UL	NEMKO, UL	-	-
Protective treatment		"TC"			
Degree of protection		Conforming to IEC 60529 IP 20			
Shock resistance		Conforming to IEC 60068-2-27 22 gn for 20 ms			
Vibration resistance		Conforming to IEC 60068-2-6 5 gn (5...110 Hz)			
Ambient air temperature around the device		Storage	°C - 40...+ 80		
		Operation	°C - 20...+ 60		
Flame resistance		Conforming to IEC 60695-2-1 °C 960			
Maximum operating altitude		m 3000			
Operating position		In relation to normal vertical mounting plane			
		GB2 CB, CD, CS		GB2 DB	
Cabling			Minimum c.s.a.		Maximum c.s.a.
		Solid cable	mm ² 1 x 0.75	1 x 6 or 2 x 4	
		Flexible cable with cable end	mm ² 1 x 0.75	1 x 4 or 2 x 2.5	
Tightening torque		N.m 1.2			

Technical characteristics										
Utilisation category		Conforming to IEC 60947-2		A		A		A		A
Rated operational voltage (U _e)		Conforming to IEC 60947-2		V 415 (1)		250		415		415 (1)
		Conforming to CSA C22-2 Nr 14 and UL 1077		V 277		-		277		-
Rated operational frequency		Conforming to IEC 60947-2		Hz 50/60		50/60		50/60		50/60
Rated impulse withstand voltage (U _{imp})		Conforming to IEC 60947-2		kV 4		4		4		4
Total power dissipated per pole				W 2		2		2		1.9
Mechanical and electrical durability		C.O.: Closing - Opening		C.O. 8000		8000		8000		8000
Operational current correction coefficient (~ or ---)		According to the permissible ambient temperature		°C - 20		- 10		0		+ 10
		Correction coefficient		1.2		1.15		1.1		1.05
				1		0.95		0.90		0.85
Tripping threshold		Of the magnetic trips		12...16 I _n		12...16 I _n		12...16 I _n		5...7 I _n

(1) One GB2 circuit-breaker on each live conductor.

Tripping curves

Average operating time at 20 °C without prior current flow (cold state)

GB2 CB, GB2 CD, GB2 DB

GB2 CS

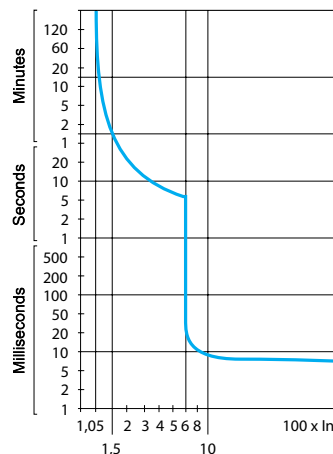
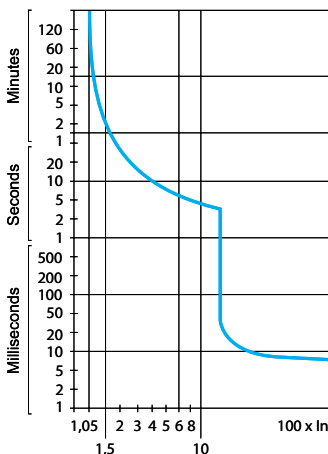

TeSys protection components

Thermal-magnetic circuit-breakers TeSys GB2 for the protection of industrial equipment control circuits

3

Circuit-breaker type			GB2													
Rating			A	CB05	CB06	CB07	CB08	CB09	CB10	CB12	CB14	CB16	CB20	CB21	CB22	
Breaking capacity conforming to IEC 60947-2 ~ 50/60 Hz	110 V	l _{cu}	kA	50	50	15	10	6	3	3	3	2	2	2	2	
		l _{cs} % (1)		100	50	50	50	50	75	75	75	75	75	75	75	75
	230/240 V	l _{cu}	kA	50	50	15	3	3	2	1.5	1.5	1.5	1.5	1.5	1.5	1.5
		l _{cs} % (1)		25	25	25	50	50	75	75	75	75	75	75	75	75
	400/415 V	l _{cu}	kA	50	50	15	3	3	2	1.5	1.5	1.5	1.5	1.5	1.5	1.5
		l _{cs} % (1)		25	25	25	50	50	75	75	75	75	75	75	75	75
Associated fuses, if required if I _{sc} > breaking capacity I _{cu} conforming to IEC 60947-2	110 V	aM	A	★	★	20	25	25	40	40	50	50	63	63	63	
		gG	A	★	★	25	32	32	50	50	63	63	80	80	80	
	230/240 V	aM	A	★	★	16	20	20	32	32	40	40	50	50	50	
		gG	A	★	★	25	32	32	40	40	50	50	63	63	63	
	400/415 V	aM	A	★	★	16	20	20	32	32	40	40	50	50	50	
		gG	A	★	★	25	32	32	40	40	50	50	63	63	63	

Circuit-breaker type			GB2													
Rating			A	CD05	CD06	CD07	CD08	CD09	CD10	CD12	CD14	CD16	CD20	CD21	CD22	
Breaking capacity conforming to IEC 60947-2 ~ 50/60 Hz	110 V	l _{cu}	kA	50	50	15	10	6	3	3	3	2	2	2	2	
		l _{cs} % (1)		100	50	50	50	50	75	75	75	75	75	75	75	75
	230/ 240 V	l _{cu}	kA	50	50	15	3	3	2	1.5	1.5	1.5	1.5	1.5	1.5	1.5
		l _{cs} % (1)		25	25	25	50	50	75	75	75	75	75	75	75	75
	Associated fuses, if required if I _{sc} > breaking capacity I _{cu} conforming to IEC 60947-2	110 V	aM	A	★	★	20	25	25	40	40	50	50	63	63	63
			gG	A	★	★	25	32	32	50	50	63	63	80	80	80
230/240 V	aM	A	★	★	16	20	20	32	32	40	40	50	50	50		
	gG	A	★	★	25	32	32	40	40	50	50	63	63	63		

Circuit-breaker type			GB2													
Rating			A	DB05	DB06	DB07	DB08	DB09	DB10	DB12	DB14	DB16	DB20	DB21	DB22	
Breaking capacity conforming to IEC 60947-2 ~ 50/60 Hz	110 V	l _{cu}	kA	50	50	15	10	6	3	3	3	2	2	2	2	
		l _{cs} % (1)		100	50	50	50	50	75	75	75	75	75	75	75	75
	230/240 V	l _{cu}	kA	50	50	15	3	3	2	1.5	1.5	1.5	1.5	1.5	1.5	1.5
		l _{cs} % (1)		25	25	25	50	50	75	75	75	75	75	75	75	75
	400/415 V	l _{cu}	kA	50	50	15	3	3	2	1.5	1.5	1.5	1.5	1.5	1.5	75
		l _{cs} % (1)		25	25	25	50	50	75	75	75	75	75	75	1.5	75
Associated fuses, if required if I _{sc} > breaking capacity I _{cu} conforming to IEC 60947-2	110 V	aM	A	★	★	20	25	25	40	40	50	50	63	63	63	
		gG	A	★	★	25	32	32	50	50	63	63	80	80	80	
	230/240 V	aM	A	★	★	16	20	20	32	32	40	40	50	50	50	
		gG	A	★	★	25	32	32	40	40	50	50	63	63	63	
	400/415 V	aM	A	★	★	16	20	20	32	32	40	40	50	50	50	
		gG	A	★	★	25	32	32	40	40	50	50	63	63	63	

(1) As % of I_{cu}.
★ Fuse not required. Breaking capacity I_{cu} > I_{sc}.

TeSys protection components

Thermal-magnetic circuit-breakers TeSys GB2 for the protection of industrial equipment control circuits

Circuit-breaker type				GB2											
				●●05	●●06	●●07	●●08	●●09	●●10	●●12	●●14	●●16	●●20	●●21	●●22
Breaking capacity (Icu) conforming to IEC 60947-2	24 V	kA		1.5	1.5	1.5	1.5	1.5	1.5	1.5	1.5	1.5	1.5	1.5	1.5
	48 V	kA		1	1	1	1	1	1	1	1	–	–	–	–
Operational current conforming to IEC 60947-5-1	DC-12	24 V	A	0.5	1	2	3	4	5	6	8	10	12	16	20
		48 V	A	0.5	1	2	3	4	5	6	8	10	12	16	20
	DC-13	24 V	A	0.5	1	2	3	4	5	6	8	10	12	16	20
		48 V	A	0.5	1	2	3	4	5	6	8	–	–	–	–
	Circuit-breaker type				GB2										
	Rating				A	0.5						1			
Breaking capacity (Icu) conforming to IEC 60947-2 ~ 50/60 Hz	110 V	Icu	kA	50						50					
		Ics % (1)		100						100					
	230/240 V	Icu	kA	50						50					
		Ics % (1)		25						25					
400/415 V (2)	Icu	kA	50						50						
	Ics % (1)		25						25						
Breaking capacity (Icu) conforming to IEC 60947-2	24 V	kA	1.5						1.5						
	48 V	kA	1						1						
Operational current conforming to IEC 60947-5-1	DC-12	24 V	A	0.5						1					
		48 V	A	0.5						1					
	DC-13	24 V	A	0.5						1					
		48 V	A	0.5						1					
	Maximum permissible line length for star-delta starting (length of cable containing 2 or more conductors)	With contactors LC● D09 ...D18	Operational voltage	V	48	110	230	48	110	230					
			C.s.a.	060 mm ²	m	(3)	31	365	6	85	230				
0.75 mm ²				m	(3)	39	460	8	110	290					
1 mm ²				m	(3)	52	610	10	145	380					
1.5 mm ²				m	(3)	78	910	15	220	570					
2.5 mm ²				m	(3)	130	1520	26	360	950					
4 mm ²				m	(3)	200	2400	41	580	1500					
With contactors LC● D25...D32			Operational voltage	V	48	110	230	48	110	230					
			C.s.a.	0.60 mm ²	m	(3)	(3)	230	(3)	56	230				
				0.75 mm ²	m	(3)	(3)	290	(3)	70	290				
				1 mm ²	m	(3)	(3)	390	(3)	95	380				
				1.5 mm ²	m	(3)	(3)	580	(3)	140	570				
		2.5 mm ²		m	(3)	(3)	970	(3)	230	950					
4 mm ²		m		(3)	(3)	1500	(3)	375	1500						
With contactors LC● D40...D80		Operational voltage	V	48	110	230	48	110	230						
		C.s.a.	0.60 mm ²	m	(3)	(3)	46	(3)	13	100					
			0.75 mm ²	m	(3)	(3)	60	(3)	17	130					
			1 mm ²	m	(3)	(3)	80	(3)	22	170					
			1.5 mm ²	m	(3)	(3)	120	(3)	34	250					
			2.5 mm ²	m	(3)	(3)	190	(3)	56	420					
			4 mm ²	m	(3)	(3)	310	(3)	90	680					

(1) As % of Icu.
 (2) One GB2 CS circuit-breaker on each live conductor.
 (3) Use relays.



TeSys protection components

Thermal-magnetic circuit-breakers TeSys GB2 for the protection of industrial equipment control circuits

534268



GB2 CB●●

Circuit-breakers with magnetic tripping threshold: 12 to 16 In

Single-pole				
Conventional rated thermal current I _{th} (1)	Magnetic tripping current I _d ± 20 %	Sold in lots of	Unit reference	Weight
A	A			kg
0.5	6.6	6	GB2 CB05	0.060
1	14	6	GB2 CB06	0.060
2	26	6	GB2 CB07	0.060
3	40	6	GB2 CB08	0.060
4	52	6	GB2 CB09	0.060
5	66	6	GB2 CB10	0.060
6	83	6	GB2 CB12	0.060
8	108	6	GB2 CB14	0.060
10	138	6	GB2 CB16	0.060
12	165	6	GB2 CB20	0.060
16	220	6	GB2 CB21	0.060
20	270	6	GB2 CB22	0.060

3

534269



GB2 CD●●

Single-pole + neutral				
Conventional rated thermal current I _{th} (1)	Magnetic tripping current I _d ± 20 %	Sold in lots of	Unit reference	Weight
A	A			kg
0.5	6.6	6	GB2 CD05	0.070
1	14	6	GB2 CD06	0.070
2	26	6	GB2 CD07	0.070
3	40	6	GB2 CD08	0.070
4	52	6	GB2 CD09	0.070
5	66	6	GB2 CD10	0.070
6	83	6	GB2 CD12	0.070
8	108	6	GB2 CD14	0.070
10	138	6	GB2 CD16	0.070
12	165	6	GB2 CD20	0.070
16	220	6	GB2 CD21	0.070
20	270	6	GB2 CD22	0.070

534270



GB2 DB●●

2-pole				
Conventional rated thermal current I _{th} (1)	Magnetic tripping current I _d ± 20 %	Sold in lots of	Unit reference	Weight
A	A			kg
0.5	6.6	3	GB2 DB05	0.115
1	14	3	GB2 DB06	0.115
2	26	3	GB2 DB07	0.115
3	40	3	GB2 DB08	0.115
4	50	3	GB2 DB09	0.115
5	66	3	GB2 DB10	0.115
6	83	3	GB2 DB12	0.115
8	108	3	GB2 DB14	0.115
10	138	3	GB2 DB16	0.115
12	165	3	GB2 DB20	0.115
16	220	3	GB2 DB21	0.115
20	270	3	GB2 DB22	0.115

(1) Conforming to IEC 60947-1.

Circuit-breakers with magnetic tripping threshold: 5 to 7 In



GB2 CS●●

Single-pole					
Conventional rated thermal current I _n (1)	Magnetic tripping current I _d ± 20 %	Sold in lots of	Unit reference	Weight	
A	A			kg	
0.5	3.3	6	GB2 CS05	0.055	
1	6	6	GB2 CS06	0.055	

(1) Conforming to IEC 60947-1.

Accessories for circuit-breakers GB2-CB, DB and CS

Description	Sold in lots of	Unit reference	Weight
Busbar set for supply to 10 GB2 DB or 20 GB2 CB or GB2 CS with 2 connectors	1	GB2 G210	0.100
Supply connector	10	GB2 G01	-

Dimensions

GB2 CB●●, GB2 CD●●, GB2 CS●●

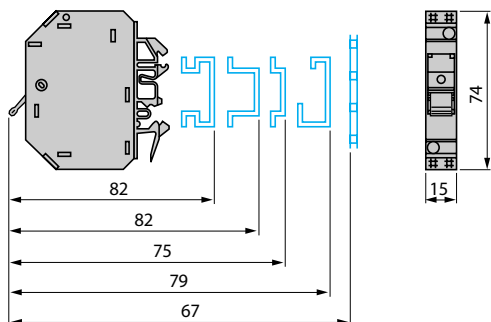

GB2 DB●●

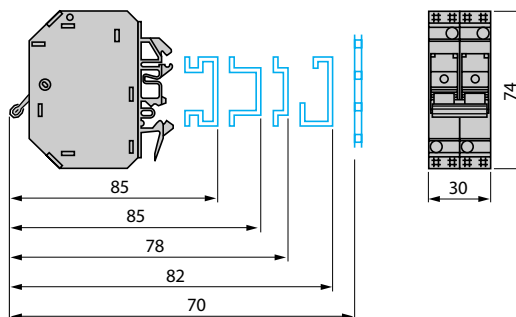

Marking: up to twelve AB1 R clip-in markers.

Schemes

GB2 CB●●

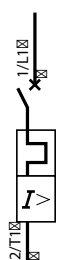

GB2 CD●●

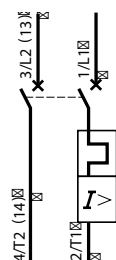

GB2 DB●●

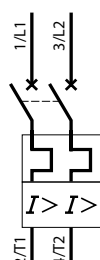

GB2 CS●●

